



**INSTRUCTION
MANUAL**

CATHODE-RAY OSCILLOSCOPE

TYPE 511



TYPE 511 CATHODE-RAY OSCILLOSCOPE

INSTRUCTION MANUAL

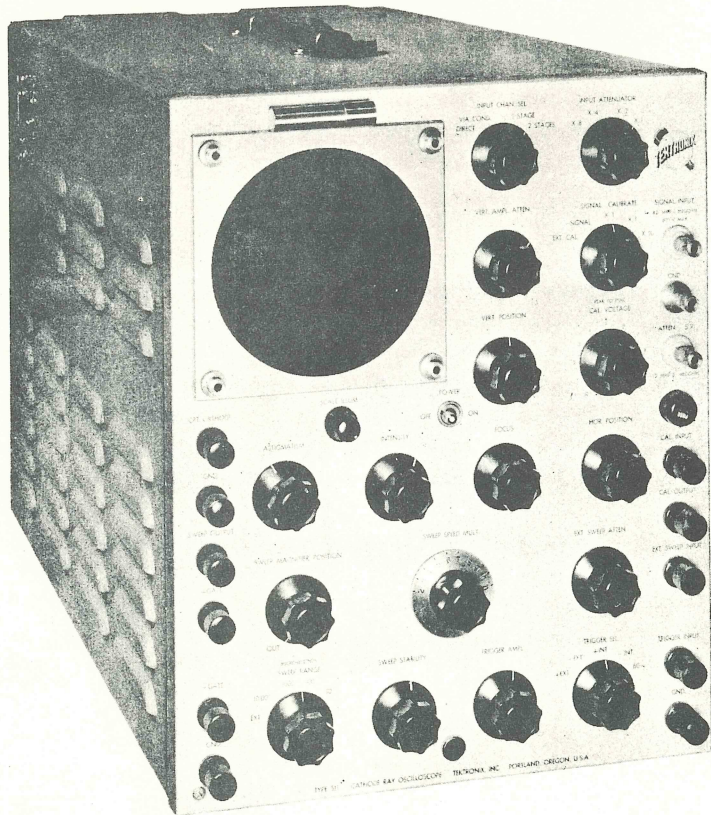

Manufacturers of Cathode-Ray and Video Test Instruments

SUNSET HIGHWAY AND BARNES ROAD - P. O. BOX 831 - PORTLAND 7, OREGON, U. S. A.
PHONE: CYpress 2-2611 CABLES: TEKTRONIX

CONTENTS

GENERAL DESCRIPTION

SECTION 1

Characteristics. Functions of Controls and Binding Posts.

OPERATING INSTRUCTIONS

SECTION 2

First-Time Operation.

Sweep Circuit Adjustments--Adjustment of sweep stability. Function of trigger selector. Adjustment of trigger amplitude. Adjustment of sweep speed. Recurrent sweep. Single sweep. Sweep magnifier. Ext. sweep input.

Vertical Deflection System--Vertical amplifier. Direct connection to deflection plates.

Calibration--Signal-calibrate switch. Measurement of signal amplitudes.

Intensity Modulation (Z axis). Sweep Output. Gate Outputs.

CIRCUIT DESCRIPTION

SECTION 3

Cathode-Ray Tube Circuit.

Sweep Circuits--Trigger phase splitter. Trigger Amplifier. Trigger coupling diode. Multivibrator. Unblanking circuit. Gate output generator. Sweep generator. Sweep output cathode follower. Sweep magnifier. Sweep amplifier.

Vertical Deflection System--Probe. Input attenuator. Vertical amplifier.

Calibrator Circuits.

Power Supply.

MAINTENANCE

SECTION 4

Replacement of Components. Removal of Case. Cleaning. Inspection. Trouble Analyzing and Repair. Voltage and Continuity Tables. Waveform Photographs.

ADJUSTMENTS

SECTION 5

Operation on 210-250 Volt Line. Adjustment of: 225 Volt Regulated Supply, High Voltage Supply, Sweep Speed Calibration, Input Attenuator, Vertical Amplifier H.F. Response, Vertical Amplifier L.F. Response, Calibrator Voltage.

Exterior and Interior Photographs.

PARTS LIST AND DIAGRAMS

SECTION 6

VIDEO DELAY NETWORK AND CIRCUIT DIAGRAM

SECTION 7

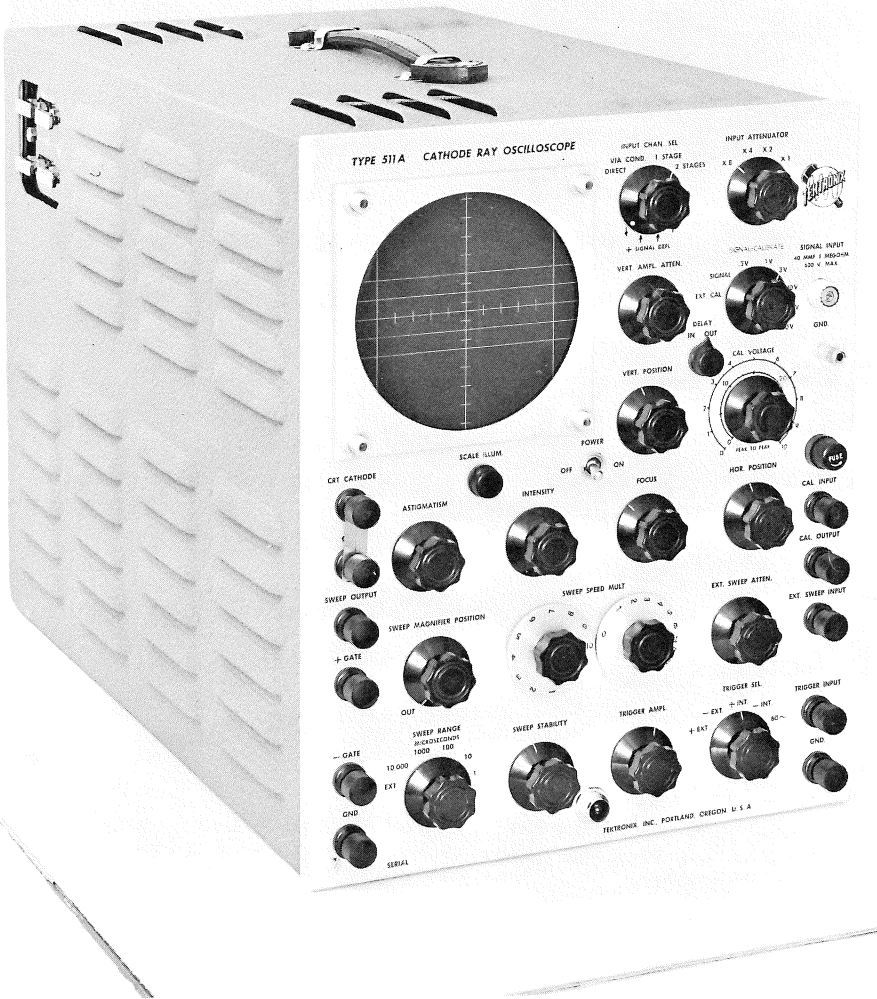

NOTE

This instruction manual has been prepared to cover TEKTRONIX Type 511, 511A and 511AD Oscilloscopes of all serial number ranges. The "Type 511A" designation is used throughout the text and will apply to the Type 511 and 511AD unless noted otherwise by the insertion of serial number range notations. The Type 511 serial number range is 101 to 454 and the Type 511A is 455 and up. The Type 511AD Oscilloscope is identical to the Type 511A except that it includes a factory installed Type 1-AD-25 Delay Network. Text, diagrams, and parts lists have been expanded to incorporate all circuit modifications adopted during the course of manufacture. The serial ranges of instruments to which various modifications were applied before shipping from the factory have been noted wherever necessary.

However, because many instruments have been modified in the field and out of serial sequence, component values and circuitry of a given instrument may differ considerably from those indicated in this manual for its serial number. The user is urged, therefore, to enter whatever changes may be necessary to bring this manual into agreement with the present circuitry of his oscilloscope.

When ordering parts, always include the following information:

1. Instrument Type (511, 511A or 511AD).
2. Instrument Serial Number (as, SN 9999).
3. Part Circuit Number (as, R999).
4. Part Description (value, type, rating, tolerance, etc.).
5. The 6-digit TEKTRONIX part number (as, 999-999).

SAFETY NOTICE

This oscilloscope employs dangerously high voltages. Since some maintenance must be performed with the case removed, great care should be taken. Use only insulated tools, stand on a dry floor and if possible keep one hand in your pocket. Care should also be used in making any connections to the deflection plates of the cathode-ray tube through the access panel. It is advised that the access panel never be removed until the power has first been turned off. The instrument should not be operated with this protective cover removed.



SECTION 1

GENERAL DESCRIPTION

The Tektronix Type 511A Cathode-Ray Oscilloscope is a wide range, portable instrument, making possible the observation of a wide variety of electrical waveshapes. It is primarily intended for laboratory and shop use, in the development and testing of all types of electronic equipment.

The Type 511AD Oscilloscope is identical to the Type 511A except that it includes a factory-installed Type 1-AD-25 Delay Network.

CHARACTERISTICS

Signals observable:

1. Sine waves from 10 cycles to 10 mc.
2. Pulses of .1 microsecond to 1/50 sec.

Sweep Circuit

Hard tube type, either triggered or recurrent as desired.

Sweep Speeds

Continuously variable from .01 sec. per cm to .1 microsecond per cm.

Trigger Requirements

.5 to 15 v (Peak) sine wave or pulse of either polarity. Pulse as short as .05 microsecond will trigger satisfactorily. A key connected between TRIGGER INPUT and GND. is suitable for triggering single sweeps. Below S/N 720, a 3 v battery and key connected in series is suitable.

Sweep Lag

CRT is unblanked and sweep is operating linearly in less than .1 microsecond after receipt of an infinitely sharp trigger pulse.

Sweep Magnification

Any desired 20% of the sweep can be spread over the entire trace except for sweep speeds faster than .5 microsecond per cm.

External Sweep Input

DC coupled via 100 K potentiometer and sweep

amplifier.

Maximum deflection sensitivity 1.5 v per cm DC or peak-to-peak AC. Band width, DC to 800 kc (3 db down at 800 kc).

Vertical Deflection Circuit

Switch permits signal input connector on panel to be connected to deflection plates directly, via capacitor (RC = .1 sec), via 1 amplifier stage, or via 2 amplifier stages.

Input Attenuator

Frequency compensated RC type with attenuation ratios of 2, 4, and 8. (S/N 101-454, ATTEN. 5X binding post allows additional attenuation.)

Vertical Deflection Sensitivity

Without amplifier 27 v/cm (5CP1A) or 13 v/cm (5ABP) maximum, 200 v/cm minimum, DC or peak-to-peak AC.

1 Stage, 2.7 v/cm (5CP1A) or 1.3 v/cm (5ABP) maximum, 40 v/cm (5CP1A) or 20 v/cm (5ABP) minimum.

2 Stages, .27 v/cm (5CP1A) or .13 v/cm (5ABP) maximum, 4 v/cm (5CP1A) or 2 v/cm (5ABP) minimum.

(Sensitivity is reduced by a factor of 10 when probe is used.)

IN NO CASE SHOULD THE COMBINED AC AND DC INPUT VOLTAGES EXCEED 600 V PEAK.

Input Impedance

1 meg shunted by 40 $\mu\mu\text{f}$ (+or-5%) for any



setting of the input selector and input attenuator. (S/N101-454, 5 meg. shunted by 12 $\mu\mu\text{f}$ when using the ATTEN. 5X binding post.)
With probe, 10 megohms shunted by 14 $\mu\mu\text{f}$.

Vertical Amplifier Bandwidth

1 stage, down 3 db (Max) (from 1 mc response) at 5 cps and 10 mc.
2 stages, down 3 db (Max) (from 1 mc response) at 5 cps and 8 mc.

Vertical Amplifier Transient Response

Risetime, 1 stage, .04 microsecond (10% to 90%) 2 stages, .05 microsecond (10% to 90%).

Calibrating Voltage

Clipped sine wave of power line frequency. Six ranges 0-.3, 0-1, 0-3, 0-10, 0-30, 0-100 volts peak-to-peak. Accuracy for line voltages from 105 to 125 v is +or-5% of full scale. A position on the SIGNAL CALIBRATE switch allows the use of an external calibrating source when desired. (Below S/N 2406—Sine wave of

power line frequency. Three ranges 0-1, 0-10, 0-100 v peak-to-peak.)

Waveforms Available Externally:

Sweep sawtooth, 20 volts peak.
Positive and negative gate, 40 v peak, same duration as sweep.

Connection to CRT Cathode

Via .1 μf capacitor. RC = .012 sec.

Accelerating voltage on cathode-ray tube, 3 KV.

Power Requirements. 105-125 volts, or 210-250 volts, 50-60 cycles, 230 watts. (See Section 5.)

Weight, 50 pounds.

Dimensions, 15 1/2" high, 12 1/2" wide, 21 1/2" deep.

Finish. Panel, photo-etched aluminum with black letters. Cabinet, gray wrinkle.

FUNCTIONS OF CONTROLS AND BINDING POSTS

A brief explanation of the function of each control and binding post is given below. For a more detailed explanation consult Section 3, Circuit Description.

PANEL MARKINGS	EXPLANATION	PANEL MARKINGS	EXPLANATION
INPUT CHAN. SEL.	--Gang switch permitting the input signal to be connected to the vertical deflection plates either directly, via a .1 μf capacitor, 1 stage amplifier, or 2 stage amplifier.	SIGNAL- CALIBRATE--	Switch which connects arm of INPUT ATTENUATOR to EXT. CAL. binding post, SIGNAL INPUT binding post, or line-frequency calibrating voltages.
INPUT ATTENUATOR-	Four position RC compensated attenuator located between the SIGNAL CALIBRATE switch and INPUT CHAN. SEL. for reducing the voltage of signals which would otherwise produce excessive deflection or overload the amplifiers.	SIGNAL INPUT--	Coaxial (binding post, S/N101-454) connector permits connection of the low-capacity probe or binding-post adapter.
VERT. AMPL. ATTEN.	--500 ohm potentiometer in cathode of cathode follower permits adjusting gain of signal amplifier.	ATTEN. 5X--	Signal input binding post having higher impedance but attenuating signals 5 times (S/N 101-454).
		DELAY (511AD only)--	Two position switch which permits the Type 1-AD-25 Delay Network to be switched in or out of the video amplifier.



PANEL MARKINGS	EXPLANATIONS	PANEL MARKINGS	EXPLANATIONS
VERT. POSITION--	Twin potentiometers controlling average potentials of vertical deflection plates and therefore the image position.	vernier control setting sweep speed and duration within range indicated by SWEEP RANGE. (A single control, S/N 101-1405).	
CAL. VOLTAGE--	Potentiometer for adjusting the clipped (unclipped, below S/N 2406) sine wave calibrating voltage of line frequency on ranges determined by the setting of the SIGNAL-CALIBRATE switch.	EXT. SWEEP ATTEN.--	Potentiometer controlling the fraction of the voltage applied to EXT. SWEEP INPUT binding post which will reach the grid of the sweep amplifiers when the SWEEP RANGE switch is set in the EXT. position.
CRT CATHODE--	Binding post permitting connection of external modulating signals to the cathode of the cathode-ray tube via a .1 μ f capacitor. RC = .012 sec.	EXT. SWEEP INPUT--	Binding post connecting to sweep amplifier via EXT. SWEEP ATTEN. when SWEEP RANGE switch is in EXT. position. (100 K input impedance).
GND.--	Connection to frame of oscilloscope.	CAL. INPUT--	Binding post connecting to EXT. CAL. position of SIGNAL-CALIBRATE switch permitting an external calibrating signal source to be permanently connected to the oscilloscope. May be used as auxiliary signal input.
ASTIGMATISM--	Potentiometer varying potential on Anode No. 2 with respect to the deflection plates. Correct adjustment of this control makes possible a sharp focus of the image in both directions simultaneously.	CAL. OUTPUT--	Binding post connected to arm of CAL. VOLTAGE potentiometer permits use of internal calibrating voltage as an external test signal of known amplitude.
SCALE ILLUM.--	Variable resistor controlling brightness of the lamp which illuminates the plastic graticule over the face of the cathode-ray tube.	+ GATE--	Binding post for connection to the cathode of the gate phase splitter (V8). This furnishes a 40 v peak positive pulse of the same duration as the sweep.
INTENSITY--	Potentiometer controlling the average grid voltage of the CRT and thereby the brightness of the image.	- GATE--	Binding post for connection via .1 μ f capacitor to the plate of (V8). This furnishes a 40 v negative pulse of the same duration as the sweep.
POWER--	On-off switch in the AC line voltage supply to the oscilloscope.	SWEEP RANGE--	Gang switch selecting appropriate coupling capacitors determining multivibrator length and sweep speed. When set to EXT. the sweep amplifier is connected to EXT. SWEEP INPUT post in place of the oscilloscope's linear sweep.
FOCUS--	Potentiometer controlling the voltage applied to the focus anode of the CRT and thereby the sharpness of the image.	SWEEP STABILITY--	Variable resistor controlling bias on grid of V4 in the multivibrator circuit. This bias determines whether the sweep will operate recurrently or must be triggered.
HOR. POSITION--	Potentiometer controlling the bias applied to grid of one sweep amplifier tube and thereby the position of the image.	TRIGGER SEL.--	Switch determining source and polarity of trigger voltage.
SWEEP OUTPUT--	Binding post connected to sweep generator via cathode follower.		
SWEEP MAGNIFIER POSITION--	Potentiometer controlling voltage applied to grid of sweep magnifier (V11) and thereby determining portion of sweep to be magnified. When turned to OUT sweep magnifier is disconnected from the circuit.		
SWEEP SPEED MULT.--	Decade control plus		



PANEL MARKINGS EXPLANATIONS

TRIGGER AMPL.---Potentiometer controlling the bias applied to the trigger amplifier tube (V2) and thereby determining the amplitude of trigger signals applied to the multivibrator.

TRIGGER INPUT---Binding post connecting external trigger sources to +EXT. and -EXT.

PANEL MARKINGS EXPLANATIONS

position of TRIGGER SEL. switch.

DEFLECTION POLARITY---Three-position lever switch mounted at the rear, which changes the V19 operating bias and the screen voltage on V18 and V19, thus providing greater undistorted deflection when observing pulses.

+SIGNAL DEFL. and arrows added at approx. S/N 2869

Dial readings: EXT. CAL., SIGNAL, X1, X1, X10--S/N 101-2405

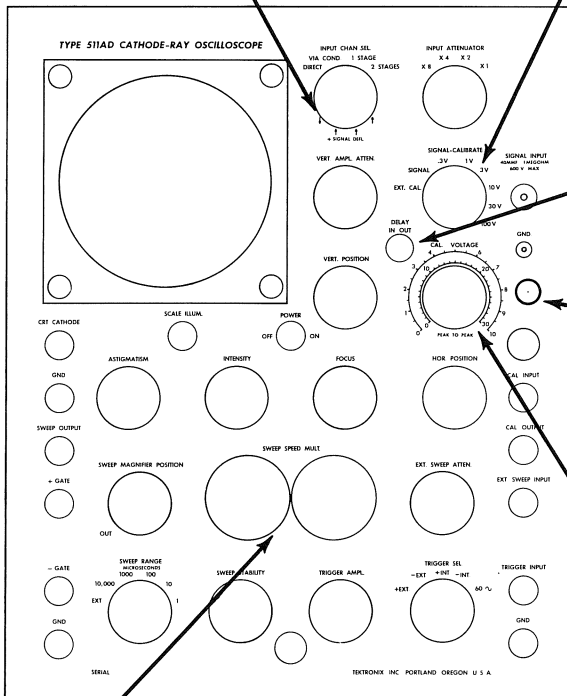

Type 511-AD only

ATTEN. 5X, S/N 101-454

One scale reading: 0-10, S/N 101-2405

SWEEP SPEED MULT. was a single dial from S/N 101-1405



SECTION 2

OPERATING INSTRUCTIONS

The Type 511A may be operated in any normal indoor location, or in the open if protected from moisture. If the instrument has been exposed to dampness, it should be left in a warm room until thoroughly dry before being placed in operation.

To prevent excessive interior temperatures, it is important to allow adequate ventilation for the oscilloscope. Several inches clearance should be provided at the sides, back and top of the case.

If the Type 511A is used continuously for the same application and only one setting of the controls is required, it is advisable to periodically check the instrument at all control settings to be sure it is in normal operating condition. For example, if only direct connection to the vertical deflection plates of the CRT is used, a defect in the vertical amplifier might not become evident. Operation of the controls also helps to prevent accumulation of dirt and tarnish on their contacts.

Although the components are well supported and the adjustments very stable in setting to allow for portable operation, the Type 511A should not be subjected to excessive vibration or rough handling.

FIRST TIME OPERATION

To place the Type 511A in operation for the first time the following procedure is suggested:

1. Connect to a source of 50-60 cycle, 105-125 v power.
2. Set controls as indicated below:
 - INPUT CHAN. SEL. 1 STAGE
 - INPUT ATTENUATOR X1
 - VERT. AMPL. ATTEN. Clockwise
 - SIGNAL-CALIBRATE 3 v (X1, below S/N2406)
 - VERT. POSITION Index vertical
 - CAL. VOLTAGE 0
 - ASTIGMATISM Index vertical
 - INTENSITY Counterclockwise
 - FOCUS Index vertical
 - HOR. POSITION Clockwise
 - SWEEP MAGNIFIER POSITION OUT
 - SWEEP SPEED MULT 5.0

- SWEEP RANGE 10,000
- SWEEP STABILITY Counterclockwise
- TRIGGER AMPL. Counterclockwise
- TRIGGER SEL. + INT.

3. Turn POWER switch to ON and wait about 30 seconds.
4. Advance INTENSITY control until a spot is seen.
5. Adjust VERT. POSITION, HOR. POSITION, ASTIGMATISM and FOCUS until a sharply focused spot is obtained at the left center of the screen.

CAUTION--DO NOT ALLOW THIS SPOT TO BE EXCESSIVELY BRIGHT OR REMAIN FOR LONG IN ONE POSITION.



6. Advance the SWEEP STABILITY control until a sweep appears, then turn it back just under this point.
7. Set the CAL. VOLTAGE control to 30 (10, below S/N 2406). A vertical line about 2.5 cm high (S/N 5100 and up) should appear. The vertical line should be about 1.25 cm high for instruments S/N 2406-5099 and 4 cm high for instruments below S/N 2406.

8. Advance the TRIGGER AMPL. control until a stable image of the calibrator waveshape appears.

The oscilloscope is now displaying the 50-60 cycle power line waveshape clipped (unclipped, below S/N 2406) by the calibrator circuits.

To observe other waveshapes connect them to the SIGNAL INPUT binding post, turn the SIGNAL-CALIBRATE switch to SIGNAL, select the appropriate sweep speed, etc.

SWEEP CIRCUIT ADJUSTMENTS

The sweep circuit of the Type 511A is different from the gas tube type usually employed in portable oscilloscopes. It is much more flexible and capable of synchronizing with much higher frequencies than conventional sweep circuits. Fundamental frequencies of 10 mc and higher can be easily observed. By one simple adjustment the sweep will run recurrently or triggered as desired.

In a recurrent or sawtooth sweep as generated by a gas tube or similar device the synchronization takes place at the end of the sweep. The sync impulse causes the beam to return to the left side of the tube where it immediately starts another sweep. Thus the sweep time must be a multiple of the signal period, or expressed another way, the sweep frequency an integral fraction of the signal frequency.

In a triggered sweep circuit each sweep is started independently of the preceding sweep by a trigger or synchronizing impulse. When no trigger is being received, the beam remains at the left side of the trace. When the trigger arrives, the beam goes linearly to the right for a time in this case determined by the multivibrator pulse length. At the end of its sweep it returns to the left side again to await another trigger. It is this variable waiting period which makes the synchronization so easy since the sweep time is now independent of the signal period. The triggered sweep makes it possible to view pulses such as used in radar and television where the length of the pulse is very short compared to the space between pulses. This requires a fast sweep with a long waiting period. Waiting periods of 2000 times the sweep length are frequently used.

Adjustment of Sweep Stability

The SWEEP STABILITY control varies the multivibrator bias and therefore determines whether the sweep will oscillate recurrently or wait for a trigger impulse. Correct functioning for triggered operation is therefore obtained when it is set just under the point where oscillation takes place. The procedure is to remove the trigger source, turn the TRIGGER AMPL. control counterclockwise, and advance the SWEEP STABILITY knob until a sweep appears and then decrease it until it just disappears.

NOTE-When using the internal trigger impulses to view fundamental frequencies above about 2 mc it will be necessary to progressively advance the SWEEP STABILITY control somewhat above the normal operating point to secure a stable pattern.

Function of Trigger Selector

This control selects the trigger impulse to be used from three sources, the line frequency, (60 cycles), the video amplifier (+ INT and -INT), or the TRIGGER INPUT binding post. Two positions are available for both the INT. and EXT. sources. When using those marked + the sweep starts at the rising portion of the trigger impulse. The -positions start the sweep on the falling portion. When the INPUT CHAN. SEL. switch is in the 2 STAGES position the + INT and -INT positions are reversed in polarity since the trigger impulses are shifted 180° by the pre-amplifier stage. For satisfactory operation in the EXT. positions a trigger of from .5 v to 15 v peaks should be provided. Larger triggers should be reduced by an external attenuator.



Adjustment of Trigger Amplifier

The TRIGGER AMPL. control adjusts the bias in the trigger amplifier and therefore the amplitude of the impulse which reaches the multi-vibrator. After the SWEEP STABILITY is set as described previously, and the TRIGGERSEL. switch set to the correct position, advance the TRIGGER AMPL. control until a stable image is obtained. When the trigger source is a slowly changing wave such as a sine wave or sawtooth, adjustment of the TRIGGER AMPL. setting will change the phase of the signal relative to the start of the sweep.

In general, it is desirable to use the minimum TRIGGER AMPL. setting required to insure a stable image.

If poor synchronizing is experienced when the Type 511A is used to observe repetitive signals containing erratic peak voltages, such as produced by vibrating contacts, it may be possible to form a stabilized trigger signal by the use of auxiliary limiting and differentiating circuits. The TRIGGER SEL. switch should then be set to the proper EXT. polarity, and connection made to the TRIGGER INPUT.

Adjustment of Sweep Speed

The combination of SWEEP RANGE and SWEEP SPEED MULT. controls allows the operator to vary the sweep speed so that the marked portion of the graticule (10 cm) is covered by the trace in any time from .1 sec to 1 microsecond. The number of microseconds required for the sweep to traverse the 10 cm. scale is determined by multiplying the SWEEP RANGE reading by the sum of the readings of the SWEEP SPEED MULT. dials (by the reading of the SWEEP SPEED MULT. dial, below S/N 1406). This indicated reading is accurate within 5% (10%, below S/N 1406) when calibrated at the factory. Provision has been made to compensate for variations caused by different tubes, etc., by a screwdriver adjustment inside the case. Procedure for adjustment of this control is described in Section 5.

Recurrent Sweep

In case it is desirable to have a sweep without using any sort of trigger, merely advance the SWEEP STABILITY control until a stable sweep is obtained. This sweep is the conventional saw-

tooth variety as used in most oscilloscopes.

Single Sweep

The triggered sweep circuit used in the Type 511 inherently provides for single sweep operation. The beam is blanked out until the trigger simultaneously turns it on and starts the sweep. For single sweep operation a mechanical contact or hand key can be connected between the TRIGGER INPUT binding post and ground. In instruments below S/N 720 a hand key can be connected in series with a 3v battery between the TRIGGER INPUT binding post and ground. If repeated sweeps occur due to intermittent or bouncing contact, a capacitor of .1 μ f to 1 μ f should be connected across the contact for instruments S/N 720 and up. This capacitor is charged through 22 megohms and the long time constant prevents an immediate recurrence of the sweep.

Sweep Magnifier

Frequently it is desirable to examine in some detail a portion of the waveshape under observation, for instance the rate of fall of the end of a fairly long pulse. In the Type 511A the sweep magnifier circuit makes it possible to expand any desired 20% of the sweep to cover the entire tube face. When the SWEEP MAGNIFIER POSITION control is moved from the OUT position, the sweep is delayed for a variable time and then goes at about 5 times its normal rate. The operating procedure is to turn the SWEEP MAGNIFIER POSITION to OUT. Adjust the sweep speed controls so that the portion of the wave to be magnified is at the right side of the tube. Now turn the SWEEP MAGNIFIER POSITION knob clockwise until the desired signal moves in from the right to the center of the tube face. The magnified sweep is not linear over its entire trace so that it is desirable to use only the center two inches if possible. If higher magnification than five is wanted it is only necessary to change R47 to a larger value. A value of 10 K will give a magnification of about 10. The somewhat lower value chosen appears to be a more usable value in most cases.

NOTE--A sweep of 10 cm per microsecond is about the limit of the sweep amplifiers, so that care must be taken that the magnified sweep does not exceed this value.



External Sweep Input

Provision has been made for the connection of external sweep generators to the Type 511A. This might be a sine wave oscillator for frequency comparison, the sweep obtained from a "Frequency sweep" signal generator, etc., or an auxiliary slow sweep generator. The EXT.

SWEEP INPUT binding post is connected to the horizontal deflection plates via the EXT. SWEEP ATTEN. and a one stage push-pull amplifier. The entire system is DC coupled, permitting the use of very slow sweeps. With the EXT. SWEEP ATTEN. fully clockwise the deflection sensitivity is approximately 1.5 volts per cm, DC or peak-to-peak AC.

VERTICAL DEFLECTION SYSTEM

The Type 511A is equipped with a very flexible vertical deflection system capable of amplifying or attenuating as necessary a wide range of waveshapes. Since the best amplifiers and attenuators have faults, it appeared undesirable to first attenuate large signals and then amplify them back to something like their original size. It was therefore decided that the Type 511A should have a switching system so that only as much amplification as needed to get a reasonably sized image would be employed. This switch called the INPUT CHAN. SEL. has four positions, DC, VIA COND, 1 STAGE and 2 STAGES. In the DC position the SIGNAL INPUT connector is connected via the INPUT ATTENUATOR to the upper deflection plate without a coupling capacitor. The lower plate is connected to the VERT. POSITION control and bypassed for signals. The VIA COND. position is similar to the DC except a .1 μ f capacitor is in series with the deflection plate. On these two positions the deflection sensitivity is approximately 27 v per cm (13v per cm, S/N 5100 and up) DC or peak-to-peak AC, with the attenuator in the X1 position.

Normally, connection to the SIGNAL INPUT is accomplished by attaching the Binding Post Adapter, which is supplied, and a single lead. When reduced loading on the circuit under test is desired, the Input Probe should be used.

CAUTION--THE PEAK POTENTIAL APPLIED TO THE PROBE SHOULD NOT EXCEED 600 VOLTS.

Since the probe introduces an attenuation of 10X, it will be advantageous to employ a common shielded lead (no attenuation) to prevent pickup of stray fields when dealing with very low signals, if the additional circuit loading is permissible. A ground lead to the equipment under observation should be provided, and often an

earth ground is desirable.

Vertical Amplifier

With the INPUT CHAN. SEL. switch in the 1 STAGE position the SIGNAL INPUT connector is connected to the deflection plate via the INPUT ATTENUATOR, a cathode follower, the VERT. AMPL. ATTEN., and a one stage push-pull amplifier. The VERT. AMPL. ATTEN. is a 500 ohm potentiometer in the cathode of the cathode follower, allowing the gain of the amplifier to be continuously adjusted over a range of two to one, thus filling in the INPUT ATTENUATOR steps. Both low and high frequency compensation is employed to produce a wide band of uniform amplification. Careful attention has been paid to the transient response so that square wave pulses, etc. will be faithfully reproduced. The amplifiers are adjusted at the factory for optimum transient response rather than flat frequency response. A much flatter response is obtainable if desired by increasing L6, and readjusting L7, L8, L9, and L10, but overshoot will occur on steep wave fronts. With optimum transient response, the risetime (10% to 90% of full amplitude) is .04 microseconds or better. At the low frequency end of the band, the top of a 10,000 microsecond square pulse will not depart by more than 5% from flatness. The deflection sensitivity is approximately 2.7 v per cm (1.3 v per cm, S/N 5100 and up) peak-to-peak maximum.

CAUTION--CARE MUST BE TAKEN TO AVOID OVERLOADING THE AMPLIFIERS. THIS WILL BE AVOIDED IF THE IMAGE IS NOT ALLOWED TO EXCEED THE RULED SECTION OF THE GRATI-CULE, WITH THE VERT. POSITION CONTROL SET SO THAT WITH NO SIGNAL APPLIED THE SWEEP LINE IS CENTERED.



In the 2 STAGES position a wide band pre-amplifier stage is inserted between the INPUT ATTENUATOR and cathode follower. Since the bandwidth and transient response of the two stage amplifier are inferior to a single stage amplifier, this position should not be used unless it is necessary, in order to obtain a sufficiently large image. Risetime is .05 microseconds. The gain of the two stage amplifier is about 100 (S/N 5100 and up, 200) making the maximum deflection sensitivity approximately .27 v per cm (.13 v per cm, S/N 5100 and up) peak-to-peak.

The deflection polarity is inverted when the 2 STAGES position is used, resulting in downward deflection on the CRT for positive input polarity.

In instruments S/N 845 and up, a three position lever type switch is mounted at the rear of the Type 511A Oscilloscope. This switch changes the operating bias on grid No. 1 of V19 and the screen voltage on V18 and V19. With the switch set at the center (normal) position, the bias applied to V19 is equal to the bias of V18, resulting in balanced operation and equal upward and downward undistorted deflection of the trace. For normal operation, the DEFLECTION POLARITY switch should be in this position.

CALIBRATION

While the cathode-ray oscilloscope is usually employed only as a qualitative rather than a quantitative device, it is the only instrument capable of making many types of voltage and current measurements on non-sinusoidal wave shapes. To aid in this work the Type 511A incorporates an internal clipped (unclipped, below S/N 2406) sine wave voltage calibrator and associated SIGNAL-CALIBRATE switch, allowing the operator to select either the internal calibrating voltage or a suitable external source of calibrating voltage to substitute for the signal being measured.

Signal Calibrate Switch

This switch permits the vertical deflection system of the oscilloscope to be conveniently changed from the SIGNAL INPUT connector to two different sources of calibrating voltages.

If it is desired to observe pulses, the switch should be set in either the upward or downward position, corresponding to the deflection of the image on the cathode-ray tube. In the upward position, the bias of V19 is decreased, resulting in increased output of V19 and decreased output of V18, thus permitting greater undistorted upward deflection. These conditions are reversed when the deflection polarity switch is in the downward position.

Direct Connection to Deflection Plates

To allow direct connection to the deflection plates with the lowest capacity, banana jacks (S/N 101-454, screw terminals) are provided on a panel accessible through an opening in the left side of the case. By removing the jumpers the interval circuits may be disconnected. The terminal marked Y1 is the top plate and the one marked X2 is the right plate. Deflection sensitivity is approximately 27 v DC per cm (S/N 5100 and up, 13 v DC per cm) on the vertical plates and 32 v per cm (S/N 5100 and up, 18 v per cm) on the horizontal.

If positioning control is desired, the jumpers should be replaced with 1 megohm resistors and a series coupling capacitor employed. Unless balanced input is desired, the unused deflection plate should be bypassed to ground.

In the EXT. CAL. position it is connected to the binding post marked CAL. INPUT, which in turn may be connected to a source of known voltage. In the remaining six positions (S/N 2406 and up) it is connected to the center arm of the CAL. VOLTAGE potentiometer making available the internal clipped sine wave source of voltage at power line frequency in six continuously variable ranges. These six ranges furnish the following peak-to-peak voltages: 0-.3, 0-1, 0-3, 0-10, 0-30, 0-100 v, and are accurate with + or - 5% of full scale for line voltages from 105 to 125v.

For oscilloscopes below S/N 2406 in the remaining three positions the vertical deflection system is connected to the arm of the CAL. VOLTAGE potentiometer making available the internal sine wave source of voltage at power line frequency in three continuously variable ranges. These three ranges furnish the following



peak-to-peak voltages: 0-1, 0-10, 0-100 v and are accurate to $\pm 10\%$ with normal line voltage (approximately 117 v).

The CAL. INPUT binding post may be used as an auxiliary signal input. This connection is not recommended for observing high speed transients, due to the slightly greater capacity.

Measurement of Signal Amplitudes

To measure the amplitude of any signal under observation, adjust the size of the image to correspond to a convenient pair of horizontal lines on the graticule. Move the SIGNAL CALIBRATE switch to the appropriate source of calibration voltage and adjust its output until the image matches the same graticule lines to which the signal had been previously set. The calibration voltage is now equal to the signal amplitude.

CAUTION---IF THE INPUT PROBE (ATTEN. 10X) IS USED, THE SIGNAL AMPLITUDE IS EQUAL TO TEN TIMES THE CALIBRATION VOLTAGE.

The scale on the CAL. VOLTAGE potentiom-

eter is calibrated in peak-to-peak volts. If a sine wave is being measured, this may be converted to R.M.S. by dividing by 2.828.

CAUTION--DO NOT OVERLOAD THE AMPLIFIERS WHEN MAKING AMPLITUDE MEASUREMENTS.

Another method which is less accurate but more rapid is to calibrate the oscilloscope itself. Select a suitable convenient voltage in the range needed, for example 10 volts, and adjust the VERT. AMPL. ATTEN. until a convenient deflection, say 5 scale divisions, is obtained. The sensitivity is now 2 volts per division and amplitudes may be read directly. The range may be extended if desired by the INPUT ATTENUATOR and probe which has an attenuation of 10X. For instruments S/N 101-454 the range may be extended by the ATTEN. 5X binding post.

CAUTION--THE DEFLECTION POLARITY SWITCH MUST BE IN THE NORMAL (CENTER) POSITION DURING CALIBRATION TO PREVENT ERROR IN THE INDICATED AMPLITUDE. (S/N 845 and up).

INTENSITY MODULATION (Z AXIS)

If desired, signals may be impressed on the cathode of the cathode-ray tube thus modulating its brightness. The CRT CATHODE binding post is connected to the cathode via a .1 μ f capacitor. The cathode resistor is 120 K.

Since the time constant is only .012 sec. long, square pulses cannot be transmitted without some loss of shape. Its primary purpose, however, is to transmit short pulses such as timemarkers, etc.

SWEEP OUTPUT

The SWEEP OUTPUT binding post makes available the waveshape appearing on the plate of the sweep generator tube. V10 is used as a cathode follower to isolate the sweep generator from whatever is connected to the SWEEP OUTPUT post. The amplitude is approximately 20 v peak-to-peak.

GATE OUTPUTS

V8 is used as a phase splitter to provide positive and negative square waves of the same duration as the sweep. The +GATE is taken from the cathode and DC coupled, thus providing an accurately square-topped pulse even at the longest sweep times. The -GATE is taken from the plate via a .05 μ f capacitor to remove the DC component.



SECTION 3

CIRCUIT DESCRIPTION

Major circuit number changes and improvements occurred in the Type 511 Oscilloscope starting with S/N 455. At this time the Type 511 designation changed to Type 511A. Numbers in parenthesis indicate the earlier values. If your oscilloscope has a serial number between 101 and 454, please use the part number in parenthesis. For greater clarity and convenience to you, it may be desirable to cross out all of those part numbers and text sections which do not apply to your particular Tektronix instrument.

CATHODE-RAY TUBE CIRCUITS

The Type 511A uses a type 5CP1A (101-5099) or 5ABP (5100 and up) cathode-ray tube. This tube has a five inch screen and utilizes electrostatic focus and deflection. A post-accelerating electrode (intensifier) is used to provide increased brightness. The total accelerating potential is about 3000 v, giving a sharp bright image visible in normal room light.

The various negative voltages necessary to operate the tube are obtained from a voltage divider network across the -1500 v supply. R142 provides the bias voltage which controls the beam current and thereby image brightness. This control is labeled INTENSITY. C60 serves to bypass the cathode to ground via the filter capacitor C77 (C69) in the power supply. In order to bring the electron beam to a sharp focus at the screen, the potential of the second anode is adjusted by the FOCUS potentiometer R140. The ASTIGMATISM control is the potentiometer R135 connected between the +225 v (+125 v) and -140 v supplies. This control adjusts the potential of the second anode so that good focus is obtained on both horizontal and verti-

cal lines simultaneously. In order to transmit unblanking pulses to the grid of the cathode-ray tube, the .1 μ f, 2000 v capacitor, C58 is used. A similar capacitor, C59, is used to transmit external impulses such as timing markers from the CRT CATHODE binding post.

The twin potentiometers, R131A and R131B, provide a means of varying the average potentials of the vertical deflection plates and therefore vary the position of the image. These potentiometers are connected between the +225 v (+125 v) and -140 v supplies so that as one plate is made more negative the other is made an equal amount positive. By this means the average potential of the vertical plates is not changed by adjustment of the VERT. POSITION control. This is essential in order to maintain good focus over a wide area of the screen. When the DIRECT position of the INPUT CHAN. SEL. switch is used, the VERT. POSITION control adjusts the potential of the lower plate only. In this case it may be found necessary to adjust the ASTIGMATISM control to obtain the best focus.

SWEEP CIRCUITS

The sweep chassis contains the circuits necessary to deflect the electron beam horizontally across the screen at a uniform rate, starting each sweep in synchronism with the trigger impulses. Circuits are provided which cut off the beam between sweeps. Provision is made to feed various sweep circuit waveforms to binding posts for external use.

Trigger Phase Splitter

The TRIGGER SEL. switch, operating in conjunction with V1, the trigger phase splitter, selects the source of trigger signal and reverses its phase if necessary. The trigger amplifier, V2, requires a positive impulse on its grid to provide the correct trigger to the multivibrator.



When the TRIGGER SEL. switch is in the -INT or +EXT. positions, signals are taken off the cathode of V1 and do not change in polarity. Therefore a positive impulse must be supplied by the external source or vertical amplifier as the case may be. With the TRIGGER SEL. in the +INT. or -EXT. positions, signals are taken off the plate and reversed in polarity, thus providing the required positive output from negative trigger sources.

Trigger Amplifier

The 6AG7 tube, V2, serves to amplify and invert the positive trigger impulses received from V1. The TRIGGER AMPL. potentiometer, R6, varies the bias and thus controls the point on the positive trigger waveform at which V2 begins to conduct. R12 in conjunction with C4A (C3) furnishes the small amount of cathode bias necessary when the TRIGGER AMPL. potentiometer is operated in its extreme clockwise position.

Trigger Coupling Diode

The negative trigger impulses from the plate of V2 are impressed on the plate of V4 by means of the coupling diode V3. The diode is used in preference to a coupling capacitor because it disconnects the trigger amplifier from the multivibrator once the multivibrator is triggered. When the multivibrator is triggered the plate of V4 falls, making the diode plate negative with respect to its cathode and therefore non-conducting. This condition is maintained until the multivibrator completes its cycle and is ready to be triggered again.

Multivibrator

To convert the various shapes of trigger impulses into square waves of controllable duration, suitable for operating the sweep generator and unblanking the cathode-ray tube, a multivibrator is provided. This consists of two tubes V4 and V5. During the waiting period V5 is fully conducting since its grid is at cathode potential and therefore its plate is held at a low value due to the voltage drop in R23. With V5 in this condition and the SWEEP STABILITY correctly adjusted, the grid of V4 is held well below the cut-off by the voltage divider, R17 and R18. The circuit remains in this condition until a trigger impulse is received. The plate of V4 is driven down by the trigger pulse and

also the grid of V5, because of the coupling capacitor C7. The plate of V5 therefore rises carrying with it the grid of V4 causing it to conduct. This action continues until V4 is conducting and V5 cut off. This condition is maintained until the capacitor C7 discharges, raising the grid voltage of V5 to such a point that it starts to conduct. This makes the plate of V5 fall, carrying with it the grid of V4 and starting a regenerative cycle which ends with V5 conducting and V4 cut off, the condition which existed before the trigger impulse occurred. Thus the plate of V4 produces a square negative pulse and simultaneously the plate of V5 produces a positive pulse. The negative pulse is used to control the operation of the sweep generator and the unblanking of the cathode-ray tube. The positive pulse is used to furnish the plus and minus GATE voltages available at the front panel binding posts.

In instruments S/N1406 and up, the duration of the time V5 is cut off is determined by the time constant of C7, R20C, R20C1 through R20C9 (depending upon the position of S10A). The voltage applied across the circuit is substantially independent of the characteristics of the trigger impulse. To cover a range of sweep time from .1 sec to 1 microsecond, C7 has five values as selected by the SWEEP RANGE switch. The calibrated variable resistor R20C is returned to +225 volts. This makes possible the use of a larger value of C7 than would otherwise be possible, thus reducing the voltage divider action of the stray capacitances to ground in the grid circuit of V5. Variation of R20C, R20C1-9, in conjunction with the five values of C7 gives a continuously variable adjustment of multivibrator pulse length.

In instruments S/N101 to 1405, the duration of the portion when V5 is cut off is determined by the time constant R20A, R21, R22, C7 and the voltage applied to R20A, and is substantially independent of the characteristics of the trigger impulse. To cover a range of sweep time from .1 sec. to 1 microsecond, C7 has five values as selected by the SWEEP RANGE switch. In the three slowest positions R20A is returned to ground, but for the two fastest it is returned to +225 v. This makes possible the use of a larger value of C7 than would otherwise be possible, thus reducing the capacity voltage divider action of the stray shunt capacities to ground of the grid circuit of V4. Variation of R20A in conjunction with the five values of C7 gives a continuously variable adjustment of the



multivibrator pulse length.

Unblanking Circuit

During the waiting period the bias on the cathode-ray tube is such that it is completely cut off. As soon as a trigger appears and the sweep starts, it is necessary to provide a positive pulse on the grid of the cathode-ray tube and thus turn on the electron beam. This pulse should have an extremely fast rise and a very flat top so that the brightness of the image is uniform.

To secure a pulse of this nature, in instruments S/N 2869 and up, the negative pulse from the grid of V5 is limited by plate current cutoff in V7.1A before it reaches full amplitude. The voltage divider R37, R38, sets the d.c. bias on the grid of V7.1A at approximately 0 volts and supplies a negative pulse of 45 volts amplitude. C12 insures that the leading edge will be coupled through without loss of risetime due to grid and wiring capacities to ground. The 45 volt negative pulse is more than adequate to drive V7.1A into cutoff, thus producing at the plate a square, flat-topped positive pulse having an amplitude of 80 volts. To provide increased risetime, L2.1 is employed in the plate circuit of V7.1A. The cathode follower, V7.1B, serves to isolate the plate circuit of V7.1A from the capacity-to-ground of the cathode-ray tube grid and associated wiring, thus preventing any appreciable reduction in risetime due to their effect. This circuit is capable of unblanking the tube in less than .1 microsecond after a sharp trigger pulse reaches the TRIGGER INPUT binding post.

To secure a pulse of this nature, in instruments S/N 101 to 2868, the positive pulse from the multivibrator is clipped before it reaches its normal amplitude by the diode V6. The cathode of V6 is held at approximately +55 v and thus the plate cannot rise more than a few volts above this value. In order that the capacity-to-ground of the cathode-ray tube grid and its associated components and wiring should not reduce the rate of rise appreciably, the cathode follower V7 is used. This circuit is capable of unblanking the tube within .1 microsecond after a sharp trigger impulse reaches the TRIGGER INPUT binding post.

Gate Output Generator

V8 serves to isolate the gate output binding posts from the multivibrator. It receives a positive pulse on its grid of the same duration as the sweep from the plate of V5 via the voltage divider R32 and R33. C10 maintains the steep sides of the pulse. Since the plate and cathode load resistors are equal, pulses of equal size but opposite polarity appear at the plate and cathode. The +gate from the cathode has no blocking capacitor and therefore preserves the square pulse for the longest sweeps. It was not felt desirable to have the -Gate binding post carry the +225 v potential of the plate; therefore a blocking capacitor is used.

Sweep Generator

The sweep generator circuit produces the basic wave necessary to sweep the beam linearly across the tube and return it to its starting point. During the waiting period the 6AG7 tube V9 is held fully conducting since it has no bias and therefore its plate is about at ground potential. When a trigger occurs the negative pulse from the multivibrator cuts the grid of V9 off very rapidly.

In instruments S/N 1406 and up the plate rises in exponential fashion at a rate depending upon R20D, R20D1-9 (as determined by setting of S10B), R39, the voltage applied across the circuit, and C15. When the multivibrator pulse ends V9 conducts again, thus discharging C15. Since C15 is charged to only about 5% of the supply voltage the rate of rise is very nearly linear. Five values of C15 as determined by the SWEEP RANGE switch in combination with the variable resistors R20D and R20D1-9 provide a continuous variation of sweep speed of from .1 sec to 1 microsecond for a 10 cm sweep. In order to maintain the correct multivibrator pulse length as the sweep speed is increased, the SWEEP RANGE switch changes C7 in the multivibrator and C15 simultaneously. In a like manner the SWEEP SPEED MULT. controls are dual controls changing R20C, R20D and R20C1-9, R20D1-9 simultaneously. In order to maintain the calibration of the SWEEP SPEED MULT. dials when tubes are changed, etc., the voltage applied to R20D may be varied by R42 which sets the grid potential of the cathode follower V15. The use of the cathode follower instead of a potentiometer maintains a constant charging potential as R20D, R20D1-9 is



varied. Details of this adjustment may be found in Section 5. The two resistors R39.11 and R39.12 connected in series are shunted across R20D1-9 to compensate for the plate circuit loads of V9.

In instruments S/N 101-1405, the plate rises in exponential fashion at a rate depending on R20B, R39, and C15. When the multivibrator pulse ends V9 conducts again, thus discharging C15. Since C15 is charged to only about 5% of the supply voltage, the rate of rise is very nearly linear. Five values of C15 as determined by the SWEEP RANGE switch in combination with the variable resistor R20B provide a continuous variation in sweep speed of from less than .1 sec. to 1 microsecond for 10 cm sweep. In order to maintain the correct multivibrator pulse length as the sweep speed is raised, the SWEEP RANGE switch changes C7 in the multivibrator and C15 simultaneously. Likewise the SWEEP SPEED MULT. is a twin control changing R20A and R20B simultaneously. To maintain the calibration of the SWEEP SPEED MULT. dial when tubes are changed etc., the voltage applied to R20B may be varied by R42 which sets the grid potential of the cathode follower V15. The use of the cathode follower in place of a potentiometer maintains a constant charging potential as R20B is varied. To maintain the calibration of the SWEEP SPEED MULT. dial in instruments S/N 101-454 a voltage regulator tube V15 holds the voltage constant. The voltage applied to R20B from V15 may be varied by R42. Details of this adjustment will be found in Section 5.

Sweep Output Cathode Follower

To provide the necessary isolation between capacities fastened to the SWEEP OUTPUT binding post and the sweep generator, the cathode follower V10 is provided. The grid of V10 is connected to the plate of the sweep generator. The SWEEP OUTPUT binding post is connected to the cathode of V10 without a blocking capacitor.

Sweep Magnifier

The function of this circuit is to delay the start of the sweep for a variable time, and then cause it to go at five times its normal speed. This is accomplished by the biased, cathode-coupled amplifier V11. In this type of amplifier a positive change in the grid potential of V11A raises both cathodes and therefore corresponds to a negative change on the grid of V11B. Thus the plate of V11 gives an amplified version of

the signal on the grid of V11A, without change of polarity. The SWEEP MAGNIFIER POSITION potentiometer raises the potential on the grid of V11B above ground and thus the cathode potential of V11A. No sweep appears on the plate of V11B until the plate of the sweep generator overcomes this bias, then the amplified sweep appears. Sufficient bias is available on the SWEEP MAGNIFIER POSITION to make it possible to start the magnified sweep at any point on the normal sweep. V6 is employed as a DC restorer, in instruments S/N 455 and up, to insure that the magnified sweep will start at the same potential each time, thus preventing jitter or instability of the trace. When the magnified sweep is not desired, the SWEEP MAGNIFIER POSITION knob is turned to the OUT position which operates a SPDT switch connecting the sweep amplifier directly to the plate of the sweep generator.

Sweep Amplifier

The sweep voltage at the plate of V9 is only about 20 v amplitude. To sweep the spot across the screen, about 350 v is necessary. The sweep amplifier provides the necessary amplification and in addition converts the single sided voltage from the sweep generator into a balanced voltage suitable for deflecting the beam. This balanced voltage is necessary to maintain the average potential of the deflection plates constant over the entire sweep, and thus prevent defocussing. The amplifier which does this uses a cathode-coupled circuit consisting of the triode connected 6AU6 tubes V13 and V14. The action of this circuit is the same as described for the sweep magnifier except that load resistors are present in both plates. The HOR. POSITION control varies the bias on V14 and thus determines the position from which the sweep starts. To insure that the sweep will always start at the same point on the screen each time (at a given setting of the HOR. POSITION control), the 6AL5 restorer diode V12 is connected between the grid of V13 and ground. This diode removes any charge which C20 may have gained during the sweep.

High frequency compensation provides sufficient band width to amplify the 1 microsecond sweep with good linearity.

This is accomplished by the bypassing effect of C22, which at high frequencies reduces the degeneration introduced in the cathode circuit by R65 and R66.



When the SWEEP RANGE switch is on the EXT. position, the input to the sweep amplifier is shifted from the sweep generator to the arm of the EXT. SWEEP ATTEN. potentiometer.

To obtain good focus on a cathode-ray tube, it is necessary that the final anode and both pairs of deflection plates have approximately the same average potential. Since it is necessary to have the vertical plates at ground potential so that a direct connection can be made, the average potential of the horizontal plates must also be near ground. The mean potential of the

sweep amplifier plates is about +250 v. This is moved down to ground by means of the group of neon glow lamps. A steady current of about 200 microamperes keeps them ionized so that any changes in the plate potentials of the sweep amplifiers appear on the deflection plates unchanged in amplitudes, but moved down 250 v. The biasing current is obtained from the -1500 v cathode-ray power supply via the voltage dropping resistors R153 and R154. Since the impedance of the neon glow lamps is rather high at frequencies involved in the fastest sweeps, C24 and C25 are shunted across them to transmit these frequencies.

VERTICAL DEFLECTION SYSTEM

The vertical deflection system provides the means of attenuating or amplifying input signal amplitudes so that they may present a convenient image on the cathode-ray tube. Signals may be attenuated as much as 8 times (40 times, S/N 101-454) or amplified as much as 100 times without appreciable change in shape.

Probe

A frequency compensated signal input probe is supplied to provide reduced loading on the circuit under observation. It consists of a 9 megohm series resistor paralleled with a compensating capacitor, and provides an input impedance of 10 megohms shunted by 14 μf .

The DEFLECTION POLARITY switch, S9 (S/N 845 and up), permits the operating bias on grid No. 1 of V19 to be varied. With the switch set at the center (normal) position, the bias applied to V19 is equal to the bias of V18, resulting in balanced operation and equal upward and downward undistorted deflection of the trace.

In the upward position, the bias of V19 is decreased, resulting in increased output of V19 and decreased output of V18, thus permitting greater undistorted upward deflection. These conditions are reversed when the deflection polarity switch is in the downward position.

The 6AG7 cathode follower V17 serves primarily as an impedance transformer so that a low resistance potentiometer can be used as a gain control. It is necessary that the potentiometer have a low value so that stray capacities

do not appreciably vary the frequency response as the control is varied. To prevent overloading the cathode follower, the VERT. AMPL. ATTEN. has a stop limiting its attenuation to a maximum of 2. This is sufficient to cover the steps of the INPUT ATTENUATOR. The coupling capacitor C49 serves to remove the DC component from the VERT. AMPL. ATTEN. so that the image does not jump around if the control is moved suddenly. Another function of the cathode follower is to permit the insertion of a delay network in the video amplifier. The chassis of the Type 511A (S/N 455 and up) is drilled to permit the insertion of a Tektronix Type 1-AD-25 Delay Network. This delays the signals .25 microseconds without appreciable distortion. A panel switch permits the removal of the delay when desired. When the delay network is factory installed, the oscilloscope is designated as Type 511AD.

A delay line of 600 ohm impedance can be inserted between C49 and the VERT. AMPL. ATTEN. in the Type 511 Oscilloscope or the Type 1-25-AD Delay Network, designed for use with this instrument, may be installed (S/N 101-454). Since the triggering of the Type 511 is much more rapid than most oscilloscopes a delay of about .2 microseconds is adequate.

When the INPUT CHAN. SEL. switch is in the 2 STAGES position, the 6AG7 pre-amplifier V16 is in the circuit. This stage employs the same compensation system as the output amplifier. Variable resistor R99 controls the low frequency response, and L4 and L5 the high frequency response. The negative bias from the



voltage divider R90 and R91 places the tube on the correct portion of its operating curve. So that the screen dissipation will not be excessive, the screen voltage is supplied through R95. C45A keeps the potential relatively constant when signals are applied to the control grid.

CAUTION-ALTHOUGH THE PROBE INTRODUCES A SIGNAL ATTENUATION OF 10 TIMES, IT SHOULD NOT BE CONNECTED TO CIRCUITS WITH PEAK VOLTAGES EXCEEDING 600 VOLTS.

Input Attenuator

All signals and calibrating voltages pass through a four position, RC compensated attenuator having attenuation ratios of 1, 2, 4 and 8. If a conventional resistance voltage divider is shunted by capacitors whose values bear the inverse ratio to the resistor values, the attenuation is independent of frequency. The attenuator is designed to have an input resistance of 1 meg shunted by 40 $\mu\mu\text{f}$ for all positions. Since the input circuits to the amplifiers and deflection plate are arranged to present 1 meg shunted by 40 $\mu\mu\text{f}$, the values chosen for the attenuator are such that correct operation is obtained when these values are in parallel with the shunt arm. The capacitors, C32, C35, and C38, shunted across the attenuators have no effect on the attenuation ratio but are adjusted so as to keep the input capacity at 40 $\mu\mu\text{f}$.

Vertical Amplifier

The Type 511A contains a wide range two-stage vertical amplifier with a switching ar-

angement so that only one stage may be used if desired. The first stage which is used only in the 2 STAGES position of the INPUT CHAN. SEL. switch uses a 6AG7 tube V16.

The output stage is a cathode coupled, push-pull 6AG7 stage, providing approximately 110 v of undistorted output. The operation of this stage is the same as that of the sweep amplifier stage. The use of a push-pull stage is required to give sufficient output and maintain the average potential of the deflection plates constant so as to prevent defocussing the beam. Low frequency compensation is provided to correct for the effect of the coupling capacitors. The resistors R110 and R125 along with the capacitors C51A and C51B provide a rising low frequency characteristic together with a phase correction. To take up variations in the component values, the grid resistor R116 is made adjustable. The procedure for this adjustment is given in Section 5. The inductances, L7, L8, L9 and L10 provide the high frequency compensation. A four terminal coupling network is used to give the greatest possible bandwidth. Every precaution has been taken to obtain the smallest stray capacities consistent with good mechanical construction.

To increase the undistorted deflection when observing pulses of a particular polarity, provision is made in instruments S/N 845 and up to move the operating point of the push-pull output amplifier from its normal position to one which allows almost the entire output swing to be utilized in either one direction or the other.

CALIBRATING CIRCUITS

CAUTION--THE SCALES OF THE CAL. VOLTAGE CONTROL INDICATE PEAK-TO-PEAK VOLTS, NOT RMS. MULTIPLY RMS BY 2.828 TO CONVERT TO PEAK-TO-PEAK.

The Type 511A (S/N 2406 and up) calibrator waveform is derived from the line-frequency voltage of a 280 volt T1 secondary winding. The positive peak is clipped (limited) by the diode connected section of a 12AT7, V16.1. The point of limiting is determined by the setting of the CAL. ADJ. potentiometer, R75.4. Since the

voltage across R75.4 is obtained from the +225 volt regulated supply, the point of limiting is not affected by line voltage variations from 105 to 125 volts, thus the accuracy of the output voltage is held within +or-5% of full scale for these line voltage variations. This limited waveform is applied to the cathode follower section of V16.1 which clips the negative peak and provides six ranges of calibrating voltage by employing a six step precision voltage divider as the cathode follower load. Continuously variable output voltage from each range is obtained from the CAL. VOLTAGE potentiometer which



may be connected to any one of the six steps of the precision voltage divider.

The SIGNAL-CALIBRATE switch S3.1, permits selection of the SIGNAL INPUT, CAL. INPUT (which may be used as an alternate signal input), or any one of the six calibrating ranges from .3 v to 100 v peak-to-peak.

In oscilloscopes S/N 101-2405, the calibrator waveform is a line frequency sine wave (unclipped) derived from the T1 secondary. When the SIGNAL-CALIBRATE switch is put in the EXT. CAL. position, the INPUT ATTENUATOR is disconnected from the SIGNAL INPUT binding post and connected to the EXT. CAL. post. The positions marked X.1, X1, and X10 connect the INPUT ATTENUATOR to the arm of the 5K wire-wound potentiometer R76. In the X10 position the high side of R76 is connected via S3A to a 10 v (peak-to-peak) winding in the power transformer. The X1 and X.1 voltages

are obtained by means of dropping resistors R74 and R75 from the 6.3 v winding in oscilloscopes S/N 455-2405. In S/N 101-455 oscilloscopes a 10 v (peak-to-peak) winding is selected, and for the X.1 range a dropping resistor R75 is placed in series with R76. The arm of R76 is connected to the CAL. OUTPUT binding post so that the calibrating voltage may be measured when increased accuracy is required.

CAUTION-DO NOT ATTEMPT TO CHECK THE CALIBRATOR ACCURACY WITH AN A.C. VOLTMETER. IF INACCURACY IS SUSPECTED, THE OUTPUT SHOULD BE CHECKED BY THE COMPARISON METHOD. REFER TO SECTION 5, ADJUSTMENT OF CALIBRATOR VOLTAGE (S/N 2406 and up), FOR PROPER PROCEDURE.

Refer to Section 2 "CALIBRATION", for operating instructions.

POWER SUPPLY

(S/N 455 and up)

In order to make the operation of the Type 511A independent of line voltage variations over the range of 105 to 125 volts, all DC power supplies are electronically regulated. The accelerating potential for the CRT is obtained from an oscillator operating from the regulated +225 v supply. A single transformer supplies all of the 60-cycle power.

The principal power supply provides +225 v at approximately 250 ma. Two 5V4G tubes are used as rectifiers. The comparatively low-voltage drop of these tubes reduces the no-load voltage to which the input capacitors may be subjected. A large input capacitor, 80 μ f, reduces the ripple to about 12 volts. The electronic regulator reduces this to less than .1 volts. This circuit consists of V27, V28, V29 and their associated components. To see how this circuit works, consider what happens when the output voltage at the cathode of V27 increases for any reason. The cathode of V28 is held at a constant potential by the type 5651 voltage reference tube V29. An increase of voltage at the cathode of V27 increases the grid voltage of V28, thereby decreasing its plate voltage and consequently increasing the grid bias on V27. An increase in this bias increases the voltage drop across

V27 and thus decreases the output voltage. If a decrease in line voltage and increase in load current tend to decrease the output of the regulator, the reverse action takes place. Thus an equilibrium is reached where the regulated output voltage is held constant within very narrow limits. To improve the action of the regulator for ripple or sudden changes of load, the capacitor C70 couples the grid of V28 directly to the output. The potentiometer R159 allows adjustment of the output voltage to 225 volts when the tubes are changed, etc.

A 6X4 rectifier V24 with its cathode connected to one side of the high voltage winding, supplies a negative voltage of approximately 300 volts. The plates of V24 are tied together since it is used as a half-wave rectifier. C68 is used as the input capacitor. To provide regulation and additional filtering, the gas-filled regulator V30 is used. The 470 ohm resistor in series with the output of V30 eliminates a tendency of V30 and C21 (on the sweep chassis) to form a relaxation oscillator.

The +450 volts necessary to operate the sweep amplifier is obtained from the full-wave rectifier V21 whose output voltage is added to



the output of the main rectifier. To obtain regulation and filtering, a regulator consisting of V25 and V26 is used. This regulator operates in the same manner as the +225 supply, using the regulated +225 as reference voltage. Thus, if the +225 is not set at its correct value, the +450 volt output will also be in error.

In order to provide the + and - 1500 volts necessary to operate the CRT, an oscillator type supply is used. Since the input power to the oscillator comes from the regulated +225 volts, its output is not affected by line voltage changes. The oscillator uses the 6AQ5 tube, V31, in a conventional Hartley circuit. A high-voltage secondary on the oscillator transformer supplies

approximately 1250 v RMS to the two type 1B3GT/8016 rectifiers, V32 and V33. Filament voltages for these tubes are obtained from windings on the oscillator transformer. Since the frequency of the oscillator is fairly high (2KC), a single .05 capacitor provides adequate filtering for the +1500 volts. A filter consisting of a .05 μ f input capacitor, a 27K resistor, and a .5 μ f output capacitor is used on the -1500 volt supply because of the increased load and need for an adequate bypass on the CRT cathode. A variable resistor R165.2 (S/N 2700 and up), in series with the oscillator screen supply, provides adjustment of the -1500 volt supply to compensate for tube changes, etc. Procedure for setting this adjustment may be found in Section 5.

POWER SUPPLY

(S/N 101-454)

Five rectifier tubes are used for the various DC supplies necessary to operate the Type 511.

The +475 v supply takes its power from T1, via the 5U4G full-wave rectifier, V21. Condenser input is used. L12 and C66 provide additional filtering to remove ripple voltage.

The +275 v supply takes its power from T2, via the 5U4G full-wave rectifier, V24. C71 serves as input condenser with L13, C54, and C47 providing the necessary filtering. C54 and C47 are located on the video chassis.

A 6X5G rectifier, V25, with its cathode connected to one side of the high-voltage winding on T2 supplies a negative voltage of approximately 300 volts. The plates of V5 are tied together since it is used as a half-wave rectifier. C72 is used as input condenser. To provide regulation and additional filtering the gas-filled voltage regulator tube, V26, is used. A relatively constant voltage of 150 v is maintained across V26. The 470 ohm resistor in series with the output of V26 eliminates a tendency of V26 and C21 (on the sweep chassis) to form a relaxation oscillator.

The +225 v supply which supplies most of the critical circuits is obtained from the +475 v supply via an electronic regulator. This utilizes the 6L6, V29, as the series tube, the 6SJ7, V27, as shunt amplifier, and the VR105 regula-

tor tube, V28, as voltage standard. To see how this circuit works consider what happens when the output voltage on the grid of the shunt tube, V27, increases, since its cathode is held steady by the regulator, V28. This causes its plate current to increase and thus lower its plate voltage. V27's plate is connected to the grid of V29, the series tube. The increased bias on V29 results in an increase in its internal resistance and therefore a decrease in the output voltage. The reverse action takes place when the load increases or line voltage decreases. Thus the output is held constant within one volt for a +or-10% change in line voltage and such load changes as occur with various sweep duty cycles. To increase the effectiveness of the regulator to ripple and rapid changes of load the condenser, C75, couples the grid of V27 directly to the output. So that variations in tubes, etc., may be taken care of, the potentiometer, R167, allows adjustment of the output voltage.

The +125 v supply is obtained from the +275 v supply via the 6V6GT series regulator, V30. V30 acts as a cathode follower and since its grid is taken from the regulated +225 v supply via the voltage divider R170 and R171, it tends to maintain the cathode at a constant value regardless of its plate voltage. This type of regulator is not as perfect as the type used in the +225 v supply, but is quite satisfactory as used here. The filaments of V29 and V30 are from the



same winding which is maintained at +125 v to keep the heater-cathode potential of these tubes within the rating.

In order to supply the high voltage necessary to operate the 5CP1A cathode-ray tube, two 2X2 rectifiers, V22 and V23 are used. They receive power from the 1250 v winding on T1. V23 is connected to furnish approximately -1600 v

across C68. R152 and C69 provide additional filtering and reduce the voltage to about -1500 v. This supply also furnishes the bias current for the sweep coupling neons via R153 and R154. To obtain a positive voltage for the intensifier anode on the 5CP1A, V22 is used. C67 provides adequate filtering since the current drain is very small. R150 and R151 serve as a bleeder to discharge C67 when the power is turned off.



SECTION 4

MAINTENANCE

CAUTION--VOLTAGES HIGH ENOUGH TO BE DANGEROUS ARE PRESENT IN THIS INSTRUMENT. SINCE MUCH MAINTENANCE MUST OF NECESSITY BE DONE WITH THE CASE REMOVED, GREAT CARE SHOULD BE TAKEN. USE ONLY INSULATED TOOLS, STAND ON A DRY FLOOR, AND IF POSSIBLE KEEP ONE HAND IN YOUR POCKET.

REPLACEMENT OF COMPONENTS

Most of the components used in the construction of TEKTRONIX instruments are standard parts obtainable from any well-equipped parts distributor. Some of the components carrying 1% and 2% tolerances may not be so readily obtainable but may be purchased from the manufacturer at these tolerances. The remainder of the low-tolerance components are standard 10%- and 20%-tolerance parts that are checked at the factory for proper value or performance. Replacement parts are available on order from the factory at current net prices but in the case of standard parts, it is probably more economical of time to purchase them locally. It is not feasible to attempt to check out low-tolerance parts or matched pairs without a reasonably large stock to choose from as the rejection percentage is quite high in most cases.

This manual has been prepared to cover TEKTRONIX Type 511 Oscilloscopes of all serial number ranges. Diagrams, parts lists and text have been expanded to incorporate all instrument modifications adopted during the course of manufacture. The serial ranges of instruments to which modifications were applied before shipping from the factory have been noted wherever necessary.

However, because many instruments have been modified in the field and out of serial sequence, component values and circuitry of a given instrument may differ considerably from those indicated in this manual for its serial number. In some cases, circuits were hand-tailored during the original factory calibration and test procedure. You will find that this manual has been hand-corrected, if necessary, to show these changes according to factory records.

To assure that you will receive correct replacement parts with the minimum delay, therefore, it is important that you include a full description of the part and its appropriate 6-digit TEKTRONIX Part Number as well as the circuit number, instrument type and instrument serial number when you order.

Equivalent parts, supplied by the factory when the exact replacement parts ordered are not available, will be accompanied by an explanation and will be directly interchangeable in most cases.



REMOVAL OF THE CASE

Set the oscilloscope face downward on a padded flat surface, remove the access panel jumper plugs and the screws in the bottom, then lift off the case.

CLEANING

CAUTION--REMOVE POWER CORD AND GROUND HIGH-VOLTAGE CIRCUITS BEFORE CLEANING IS UNDERTAKEN.

At regular intervals, depending on local conditions, the dust should be removed from the interior of the Type 511A by means of dry compressed air. Avoid a high-velocity air stream which might injure the instrument or disturb adjustments. Persistent dirt may be removed with a lint-free cloth, or a small paint brush. Special attention should be given to the high voltage circuits, including parts under the high voltage cover shields, as excessive dust and moisture may cause arcing.

Under normal conditions, the silver-plated contacts of the rotary switches should not require special attention. In case they become tarnished, the contacts should be cleaned by rotating the switch several times.

INSPECTION

A visual inspection is desirable while the Type 511A case is removed during cleaning.

1. Switches. Turn the rotary switches while observing the contacts, to check contact centering in each index position. Improperly centered contacts may be due to the switch becoming warped or twisted, or in the case of S2 (SWEEP RANGE), to a loose shaft coupling.

CAUTION--AVOID PRESSURE ON THE CONTACTS AS THEY ARE EASILY DAMAGED.

2. Capacitors and Resistors. Inspect the oil-filled and electrolytic capacitors for leakage of oil or electrolyte, replacing if necessary. The wax coating of paper-tubular-capacitors may drip if the instrument has been overheated by operating in a restricted space. This condition usually does not indicate replacement. Composition resistors should be checked for serious discoloration, which would indicate excessive

dissipation and therefore faulty operation. A moderate amount of discoloration is normal.

3. Connections. Loose screws or nuts should be tightened. This is especially important when the screw serves as an electrical connection. Corrosion of the chassis and electronic components is unlikely under normal conditions. It should be removed if evident, and the cause corrected. If the instrument must be operated in a corrosive atmosphere, it may be desirable to remove the tubes occasionally and clean the contact pins with crocus cloth. Remove and insert the tubes several times to clean socket contacts.

4. Voltages (S/N 455 and up). The power-supply output voltages, -140, +225, +450, -1500 and +1500 should be checked with an accurate voltmeter. To check the voltage regulator circuits, vary the line voltage by means of a variable transformer, and with a voltmeter observe the regulation limits of the -140 v, +225 v and +450 v supplies. Compared to their value at a 117-volt line, the output voltages should be within these limits:

Supply	-140 (+2-5%)	+225 (±2%)	+450 (±6%)
105v line	-0.5%	-1%	-1%
125v line	+0.5%	+1%	+1%

CAUTION---DO NOT EXCEED A LINE VOLTAGE OF 130.

TROUBLE ANALYZING AND REPAIR (S/N 101 and up)

General

It is important that the operation, circuit theory and physical location of components be thoroughly understood before repair of the Type 511A is undertaken. If the circuit description, schematic diagram and interior photographs are carefully studied, most defects will be found relatively easy to locate.

CAUTION-BE SURE TO CHECK THE SETTING AND ADJUSTMENT OF THE CONTROLS BEFORE ATTEMPTING REPAIR, TO VERIFY THAT THE DIFFICULTY IS ACTUAL.

Although tables of average voltage and resistance values are included to facilitate servicing,



they should be used for reference only, and are not meant to serve as a "check list" or sequence chart for circuit testing. This system might eventually lead to the trouble, but the isolation or signal tracing methods are generally much faster.

Many troubles can be localized by observing the waveforms at various points in the circuits with the instrument's own cathode-ray tube. Another oscilloscope may be used if available. This method is explained in detail under servicing instructions for each chassis.

Since a large percentage of troubles experienced will likely be caused by defective tubes, it is advisable to check the tubes in the suspected circuits before carrying out extensive tests of other components. Tube testing is best accomplished by the substitution of another one known to be good. A tube tester is useful, but it may not indicate some defects which cause malfunctioning in the oscilloscope. If the tube defect has been caused by an abnormal circuit condition, this should be corrected before replacement is made. Although specially matched or selected tubes are not required in the Type 511A, some individual tubes which perform normally in less critical circuits may not function well in certain circuits of this instrument. Specific conditions are dealt with under the individual chassis headings. An accurate voltmeter having 20,000 ohms per volt or greater sensitivity, an accurate ohmmeter, spare tubes, and simple tools should be available.

CAUTION--WHEN ANY PART WHICH AFFECTS THE ADJUSTMENTS OR CALIBRATION OF THE TYPE 511A IS REPLACED, THE AFFECTED CIRCUITS SHOULD BE READJUSTED AS EXPLAINED IN THE ADJUSTMENT SECTION.

Absence of Power

When this condition is due to a blown fuse, check line voltage and, if normal, replace the fuse (3 amp, slo-blo), throw the power switch on, and check for any abnormal condition which may have caused the fuse to blow. If a short circuit or overload exists, the length of time required to blow the fuse should provide an indication of the trouble. For example, a delay until the high voltage rectifiers begin to conduct would indicate trouble in the DC supplies or

the circuits fed by them. This condition may be isolated by removing the high voltage rectifier tubes, V21, V22, V23 and V24 (including V25, S/N 101-454); and replacing first (V25, S/N 101-454) V24, then V22 and V23, and finally V21, allowing several minutes operation between each replacement. After the faulty DC supply is located, disconnect it at the power supply terminal strip, then at the video amplifier terminal strip, to further isolate the defect. See the schematic diagrams for average currents.

A five-second delay before the fuse blows might be caused by a short in the tube-heater circuits, and should also be isolated by disconnecting at the terminal strips. A delay of one second or less would suggest a short circuit on a high voltage secondary of T1.

Absence of Spot on Cathode-Ray Tube

To determine whether this is due to absence of the electron beam or to the beam being deflected off the fluorescent screen, connect together and ground all four CRT deflection plates at the access panel. If a centered spot now appears, abnormal deflection plate potentials are indicated. Remove the short circuiting connections. With the VERT. POSITION control centered, the HOR. POSITION control clockwise, the SWEEP STABILITY control counterclockwise, and no vertical input signal, measure the voltage between each CRT deflection plate and ground, which should be within ± 60 volts. The **average** potential of both horizontal (X) plates, or both vertical (Y) plates, should be within ± 40 volts of ground when measured under the above conditions. Abnormal potential on the horizontal plates indicates malfunctioning of the sweep amplifier or associated circuits; and on the vertical plates, a defective positioning circuit or shorted coupling capacitor.

If the deflection plate voltages are normal, check the CRT connections, and observe the CRT heater by viewing it through the small hole in the upper rear part of the CRT shield. Next, measure the power-supply output voltages, the CRT bias (pin 2 to pin 3), the first anode (pin 5) and the second anode (pin 9) voltages. If these readings are normal, replacement of the CRT is indicated.

Power Supply

1. If the output voltage of one of the regulated



supplies is abnormally high or low, the load current for that section may be measured to determine whether the defect lies within the power supply or the external circuits. See the schematic diagram for values. If the power supply is at fault, the rectifier output voltage should be checked. Normal rectifier output would then indicate malfunctioning of the regulator circuit. See Section 3 for a description of the voltage regulator circuits. A regulator performance test is outlined in the Inspection instructions of this section. A check of the grid-cathode bias of the series regulator tube will serve to further isolate the trouble within the regulator circuit itself. Average bias potentials (S/N455 and up) are:

Line Voltage	V27,6A57G bias	V25,6AQ5 bias
105	-14 v	-8 v
117	-36 v	-16 v
125	-56 v	-22 v

Figures 4-5 and 4-6 are oscillograms illustrating the amplitude and waveform of the normal rectifier output ripple. Any unbalance due to defective rectifier tubes or power transformer is easily observed with an oscilloscope at the cathodes of V21 and V22-V23.

2. HIGH-VOLTAGE SUPPLY (S/N455 and up). If normal -1500 and +1500 volt accelerating potentials are not restored by replacement of V13, V32, V33, and the HIGH VOLTAGE ADJ. control, the CRT heater pin plugs and accelerating anode clip should be removed to ascertain whether the power supply itself is at fault.

Next check the +225-volt supply, since the high voltage output will vary proportionately. Low output with normal oscillator (V1) grid and cathode voltages, indicates an open circuit in the secondary windings of T2, or other portions of the rectifier circuits. Low voltages at the oscillator grid and cathode would suggest shorted turns or excessive load on T2, or defective components in the oscillator primary circuit. Figures 4-7 and 4-8 are oscillograms of the oscillator waveform.

3. Heater. Since relatively large currents are present in the heater circuits, it is important that connections be clean, tight, and joints well soldered.

Sweep Circuits

Trouble in the sweep circuits is indicated when a spot on the CRT screen can be obtained, but advancing the SWEEP STABILITY control does not result in a normal sweep of at least 11 cm. deflection, and at a speed indicated by the SWEEP RANGE and SWEEP SPEED MULT. controls. An approximate location of the difficulty can usually be established by observing the amplitude and waveform of the GATE OUTPUTS, SWEEP OUTPUT, and the amplified sweep voltage at the CRT deflection plates, with another oscilloscope. Further isolation should be possible by observing the input and output waveform of each stage at the tube sockets. A comparison with figures 4-9 to 4-25, inclusive, will show whether or not operation is normal. If not, check the tubes, operating voltages and resistance values in the suspected circuit.

Instability, or jitter of the sweep, when not due to faulty triggering or to jitter in the signal being observed, is usually caused by the introduction of a 60-cycle signal due to a defective tube. This trouble may be located by tube substitution. Excessive power supply ripple may also cause jitter.

Abnormal sweep speeds (out of range of the adjustment controls R42 and C15A) may be caused by wrong time constants or charging voltage in the sweep generator, or a change in gain of the sweep amplifier.

Short sweep length (less than 11 cm when the sweep speed is properly adjusted) is due to faulty operation of the multivibrator.

1. Sweep Amplifier. A defect in the sweep amplifier may be indicated by low gain, improper horizontal positioning, non-linear sweep, or abnormal CRT deflection plate voltages. To measure the sweep amplifier gain, set the SWEEP RANGE switch at EXT. and connect the CAL. OUTPUT to the EXT. SWEEP INPUT. With the CAL. VOLTAGE adjusted to 10 volts, a deflection of approximately 6.5 cm should be obtained. After trying replacement of V12, V13 and V14, circuit operating voltages and the drop across each group of neon lamps should be measured. The potential across five NE2 neon lamps should be 280 volts + or -30 volts. If outside this value, make individual lamp measurements, and replace defective units. The operating potential of new neon lamps may be



high, but should become normal after several hours operation. Occasionally, a Type NE2 lamp will exhibit a tendency to oscillate. This condition is evidenced by a "spot" on the horizontal trace, usually near the sweep starting point. When a sine wave such as the Calibrating Voltage is applied to the CRT vertical deflection plates, the "spot" will assume the form of a damped wave train. If this trouble is encountered, short circuit the neon lamps, one at a time, until the oscillation disappears, thus isolating the defective lamp.

CAUTION--LEAKAGE AT THE SEAL
MAY RESULT IF THE NEON LAMP
LEADS ARE BENT TOO CLOSE TO THE
GLASS.

2. Sweep Generator. Faulty operation of the sweep generator is indicated when the multivibrator output is normal (fig. 4-12) and the sawtooth at the plate of V9 (fig. 4-21) is not. If the sawtooth amplitude is low (slow sweep speed), V9 is known to be good, and circuit voltages appear normal, remove V9 and measure the voltage at terminal 4 of V9 socket, which should be between +5 and +30 volts. This measurement is made with the SWEEP STABILITY control fully counterclockwise.

Error in sweep speed on one range only may be due to a defective timing capacitor, C15A, B, C, D or E. The capacity of C15E is selected from -3% to +3% of its design center and this value is stamped on its case. C15B, C and D are also selected to +or-3%, and then so matched to C15E that their capacity deviates from design center by the same amount and in the same direction as that of C15E. If it is necessary to replace one or more units, observe the capacity of C15E and select a replacement having the same percent and polarity of deviation from design center. If the exact capacity is not available, this may be accomplished by employing a capacitor of slightly lower than the required value and padding it up to the proper capacity. To preserve linearity on the slowest sweeps, use only a mineral oil-filled capacitor for C15E.

If the indicated sweep speed is accurate with the SWEEP SPEED MULT. dial set at 1.0 (in instruments S/N 1406 and up), but inaccurate at other settings suspect a change in resistance of R20D, R20D1-9 or a short or ground at some point along the step control. In the event R20D must be replaced it should be ordered

from the factory and will be supplied with an individually calibrated dial.

3. Multivibrator. It is important that the multivibrator output be of normal amplitude and free from frequency modulation. Low amplitude of the negative square-wave output will be evidenced by short sweep length, and is usually caused by a poor 6AC7, V4. This condition is more likely to appear when the Type 511A is operated at low line voltages, and therefore reduced heater temperature of V4.

Frequency modulation of the multivibrator output at line frequency is sometimes introduced by a defective 6AG7, V5. This condition makes it difficult to synchronize high frequency signals. If poor synchronizing is encountered, several type 6AG7's should be tried as new tubes often have this defect.

Poor tracking of the C, C1-9 and D, D1-9 sections of R20, the SWEEP SPEED MULT. control, may also cause short sweep length. A resistance check should reveal any trouble of this nature.

Trigger Circuits

Faulty triggering of the sweep may be caused by insufficient amplitude of the trigger impulse or the introduction of spurious signals to the multivibrator.

If triggering is erratic, it is desirable to first eliminate the possibility that instability of the signal being observed is the cause. Possible internal causes are: arcing in the high voltage supply, introduction of a 60-cycle jitter due to defective tubes V16, V17, V1, V2 or V3, excess power-supply ripple, and insufficient trigger amplifier gain.

The Type 511A should trigger on signals of .15 volt or less applied to the TRIGGER INPUT except on the 1 microsecond range, which may require slightly larger trigger input. The trigger sensitivity may be quickly measured as follows:

Connect a **short** wire between the CAL. OUTPUT and the TRIGGER INPUT binding posts, set the sweep speed at 10,000 microseconds, the SIGNAL-CALIBRATE switch at .3 v (X.1, S/N 455-2405), the CAL. VOLTAGE at 0, the TRIGGER SEL. at +EXT., the TRIGGER AMPL.



fully clockwise, and the SWEEP STABILITY at a point just below the setting required to make the sweep occur. Now advance the CAL. VOLTAGE control until a stable sweep is obtained. Repeat, using the -EXT. trigger setting. If the external trigger sensitivity is normal (.5 volt or less) but internal triggering is inadequate, V17 and associated components should be checked. See figures 4-26, 4-27, and 4-28 for typical trigger gain and waveform.

To provide smooth adjustment of the trigger impulse, a special tapered potentiometer, R6, is employed as the TRIGGER AMPL. control. It is recommended that this control be ordered from the factory if replacement is required; however, a linear potentiometer may be substituted if necessary.

Vertical Amplifier

Defects in the vertical amplifier may be isolated by introducing a test signal through a series capacitor to various circuit points, and observing the result on the 511A's cathode-ray tube.

The following precautions should be observed if it becomes necessary to replace circuit components:

1. V16, 6AG7. The heaters of some type 6AG7's introduce a line-frequency signal and may cause synchronizing difficulty, or vertical deflection of the trace at line frequency, when the INPUT CHAN. SEL. is in the 2 stages position. Since 6AG7's exhibit a marked variation of input capacity, it is desirable to check the adjustment of C44, as explained in the "Adjust of Input Attenuator" section. If satisfactory waveshape cannot be obtained, try another 6AG7.

2. C39, C51. These electrolytic capacitors are employed in the low-frequency compensating circuits, and should be replaced if the range of R99 and R116 becomes insufficient to properly compensate the amplifier. It is necessary that the actual capacity be within the limits specified in the "Parts List" section.

3. R111, R111.1, R112, R112.1, R126, R126.1, R127 and R127.1 (Below S/N 845; R110, R111, R112, R125, R126 and R127). These are V18 and V19 plate load resistors. If replacement is necessary, the values must be selected so that the total resistance of each series of four is between 1125 to 1250 ohms. After replacement, it is desirable to check the high-frequency response of the amplifier, and if necessary, readjust as explained under "Adjustment of Vertical Amplifier H.F. Response."

4. R93 and R93.2. These are the V16 plate-load resistors. Replacements should be selected for a total series value between 1175 and 1240 ohms, and the adjustment of L4 and L5 checked.

5. R107, VERT. AMPL. ATTEN. If this control must be replaced in the Type 511AD, it may be necessary to install a different value Delay Network shunt resistor. See Section 7. This control has an additional rotation stop punched in the cover; therefore the cover should be removed and installed on the new control, unless a replacement is ordered from the factory.

6. R74, R75, and R76 (S/N 101-2405). These components provide the proper CAL. VOLTAGE output, R74 and R75 being selected to match R76. Reasonably good accuracy will be obtained if 3.9 k is used for R74, 78 k for R75 and 5 k for R76. For improved performance it is suggested that Modification Kit #040-015 be ordered.

7. Wiring Dress. Since the Type 511A is designed to observe high-speed transients, it is important that the original low-capacity construction in the vertical-amplifier signal circuits be maintained. Therefore, when replacing any electronic components or wires, be sure that the original positions are maintained. The leads between the deflection-plate access panel and the CRT socket should be dressed apart and away from other conductors.

VOLTAGE AND CONTINUITY TABLES

Beginning with S/N 845 and up. The voltage and continuity readings are approximate for instruments S/N 101-844.

CAUTION--THE POTENTIALS AND RE-

SISTANCES LISTED IN THESE TABLES ARE AVERAGE VALUES. MANY OF THEM WILL EXHIBIT CONSIDERABLE NORMAL VARIATION WITH DIFFERENT INDIVIDUAL INSTRUMENTS, DUE TO



MANUFACTURING TOLERANCES OF THE ELECTRONIC COMPONENTS AND TUBE CHARACTERISTICS.

Therefore, these tables should be used only in conjunction with careful study of the Circuit Description, Maintenance section and Schematic Diagrams.

Unless otherwise specified, the readings were obtained at these control settings:

INPUT CHAN. SEL.	2 Stages
INPUT ATTENUATOR	X1
VERT. AMPL. ATTEN.	Clockwise
SIGNAL CALIBRATE	Signal
VERT. POSITION	Centered

CAL. VOLTAGE	0
ASTIGMATISM	Centered
INTENSITY	Centered
POWER	ON
FOCUS	Centered
HOR. POSITION	Clockwise
SWEEP MAGNIFIER	Out
POSITION	
SWEEP SPEED MULT.	1.0
EXT. SWEEP ATTEN.	Clockwise
SWEEP RANGE	1000 micro-seconds
SWEEP STABILITY	Counter-clockwise
TRIGGER AMPL.	Counter-clockwise
TRIGGER SEL.	+ INT.
DEFLECTION POLARITY	Centered

AVERAGE TUBE SOCKET VOLTAGES

Measured at 117 Volt Line
DC Voltmeter Sensitivity 20,000 Ohms Per Volt

Tube	Pin	To	Voltage	
V1	1,2	Gnd.	0	
	3,5	Gnd.	+15.5	
	4	Gnd.	+7 50 volt scale
	6	Gnd.	+187	
	7	Gnd.	6.5AC	
	8	Gnd.	+177	
V2	1,2	Gnd.	0	
	3,5	Gnd.	+10	TRIGGER AMPL. clockwise
	3,5	Gnd.	0	TRIGGER AMPL. counterclockwise
	4	Gnd.	0	TRIGGER AMPL. clockwise
	4	Gnd.	-20	TRIGGER AMPL. counterclockwise 50 volt scale
	6	Gnd.	+225	
	7	Gnd.	6.5AC	
	8	Gnd.	+170	TRIGGER AMPL. clockwise
8	Gnd.	+225	TRIGGER AMPL. counterclockwise SWEEP STABILITY counterclockwise	
V3				See V2 and V4 voltages
V4	1,3, 5,7	Gnd.	0	
	2	Gnd.	6.5AC	
	4	Gnd.	+1.2	SWEEP STABILITY clockwise 10 volt scale
	4	Gnd.	-42	SWEEP STABILITY counterclockwise 50 volt scale
	6	Gnd.	+36	SWEEP STABILITY clockwise
	6	Gnd.	+67	SWEEP STABILITY counterclockwise



V4	8	Gnd.	+110	SWEEP STABILITY clockwise
(cont.)	8	Gnd.	+210	SWEEP STABILITY counterclockwise
V5	1,2,	Gnd.	0	
	3,5			
	4	Gnd.	-15	SWEEP STABILITY clockwise
	4	Gnd.	-.4	SWEEP STABILITY counterclockwise 10 volt scale
	6	Gnd.	+36	SWEEP STABILITY clockwise
	6	Gnd.	+67	SWEEP STABILITY counterclockwise
	7	Gnd.	6.5AC	
	8	Gnd.	+210	SWEEP STABILITY clockwise
	8	Gnd.	+142	SWEEP STABILITY counterclockwise
(S/N 845-2868)				
V6	1	Gnd.	+ .5	
	2	Gnd.	+65	SWEEP STABILITY clockwise
	2	Gnd.	+27	SWEEP STABILITY counterclockwise
	3	Gnd.	6.5AC	
	4,7	Gnd.	0	
	5	Gnd.	+65	
(S/N 2869 and up)				
V6	1,5	Gnd.	+ .5 10 volt scale
	2,3,7	Gnd.	0	
	4	Gnd.	6.5AC	
(S/N 845-2868)				
V7	3	Gnd.	0	
	4	Gnd.	6.5AC	
	5	Gnd.	+225	
	6	Gnd.	+65	SWEEP STABILITY clockwise
	6	Gnd.	+27	SWEEP STABILITY counterclockwise
	7	Gnd.	+70	SWEEP STABILITY clockwise
	7	Gnd.	+39	SWEEP STABILITY counterclockwise
(S/N 2869 and up)				
V7.1	1,7	Gnd.	+220	SWEEP STABILITY clockwise
A,B	1,7	Gnd.	+75	SWEEP STABILITY counterclockwise
	2	Gnd.	-15	SWEEP STABILITY clockwise 50 volt scale
	2	Gnd.	0	SWEEP STABILITY counterclockwise 2.5 volt scale
	3,4,5	Gnd.	0	
	6	Gnd.	+450	
	8	Gnd.	+180	SWEEP STABILITY clockwise
	8	Gnd.	+100	SWEEP STABILITY counterclockwise
	9	Gnd.	6.5AC	
V8	1	Gnd.	+185	SWEEP STABILITY clockwise
	1	Gnd.	+215	SWEEP STABILITY counterclockwise
	3	Gnd.	6.5AC	
	4	Gnd.	0	
	6	Gnd.	+27	SWEEP STABILITY clockwise
	6	Gnd.	0	SWEEP STABILITY counterclockwise 50 volt scale
	7	Gnd.	+40	SWEEP STABILITY clockwise
	7	Gnd.	+11	SWEEP STABILITY counterclockwise



Tube	Pin	To	Voltage	
V9	1,2,3,5	Gnd.	0	
	4	Gnd.	-20	SWEEP STABILITY clockwise 50 volt scale
	4	Gnd.	+ .25	SWEEP STABILITY counterclockwise 2.5 volt scale
	6	Gnd.	+225	SWEEP STABILITY clockwise
	6	Gnd.	+32	SWEEP STABILITY counterclockwise
	7	Gnd.	6.5AC	
	8	Gnd.	+65	SWEEP STABILITY clockwise
	8	Gnd.	+3.2	SWEEP STABILITY counterclockwise
	V10	3	Gnd.	0
4		Gnd.	6.5AC	
5		Gnd.	+225	
6		Gnd.	+65	SWEEP STABILITY clockwise
6		Gnd.	+3.2	SWEEP STABILITY counterclockwise
7		Gnd.	+70	SWEEP STABILITY clockwise
7		Gnd.	+16	SWEEP STABILITY counterclockwise
V11	1	Gnd.	+156	MAGNIFIER POSITION out
	1	Gnd.	+145	MAGNIFIER POSITION clockwise
	2	Gnd.	+135	MAGNIFIER POSITION out
	2	Gnd.	+110	MAGNIFIER POSITION clockwise
	3	Gnd.	0	
	4	Gnd.	6.5AC	
	5	Gnd.	+2.5	MAGNIFIER POSITION out
	5	Gnd.	+28	MAGNIFIER POSITION clockwise
	6	Gnd.	+5 10 volt scale
	7	Gnd.	+5	MAGNIFIER POSITION out
7	Gnd.	+30	MAGNIFIER POSITION clockwise	
V12	1,5	Gnd.	+ .4 10 volt scale
	2,3,7	Gnd.	0	
	4	Gnd.	6.5AC	
V13	1	Gnd.	+ .4 10 volt scale
	2,7	Gnd.	+5	HOR. POSITION clockwise
	2,7	Gnd.	+12	HOR. POSITION counterclockwise
	3	Gnd.	6.5AC	
	4	gnd.	0	
	5,6	Gnd.	+280	HOR. POSITION clockwise
	5,6	Gnd.	+430	HOR. POSITION counterclockwise
	V14	1	Gnd.	0
1		Gnd.	+16	HOR. POSITION counterclockwise
2,7		Gnd.	+5	HOR. POSITION clockwise
2,7		Gnd.	+16	HOR. POSITION counterclockwise
3		Gnd.	6.5AC	
4		Gnd.	0	
5,6		Gnd.	+290	HOR. POSITION clockwise
5,6		Gnd.	+140	HOR. POSITION counterclockwise
V15		1,4,5	Gnd.	+450
	3	V15 pin 4	6.5AC	
	6	Gnd.	+230 to	
			+390	depending on setting of R42



Tube	Pin	To	Voltage	
V15 (cont.)	6	Gnd.	450 v	S2C ₂ in 1 microsec. pos. depending on setting of R42
	7	Gnd.	+ 260 to 400	
	7	Gnd.	440 v	
V16	1,3,5,7	Gnd.	0 10 volt scale
	2	Gnd.	6.5AC	
	4	Gnd.	-.6	
	6	Gnd.	+145	
	8	Gnd.	+150	
(S/N2406 and up)				
V16.1	1	Gnd.	+450	SIGNAL-CALIBRATE switch in .3 v position SIGNAL-CALIBRATE switch in SIGNAL position R75.4 counterclockwise R75.4 clockwise. CAUTION--Changing this adjustment necessitates recalibration. CAL. ADJ. control adjusted properly
	2,6,7	Gnd.	0	
	3	Gnd.	+45	
	3	Gnd.	+12	
	4,5	Gnd.	6.5AC	
	8	Gnd.	+75	
	8	Gnd.	+105	
	8	Gnd.	+90	
	9	Gnd.	0	
V17	1,3,5	Gnd.	+57 250 volt scale
	2	Gnd.	0	
	4	Gnd.	+45	
	6	Gnd.	+225	
	7	Gnd.	6.5AC	
	8	Gnd.	+190	
V18	1,5	Gnd.	+32	DEFLECTION POLARITY up and center DEFLECTION POLARITY down depending on setting of R116 50 volt scale DEFLECTION POLARITY up DEFLECTION POLARITY center DEFLECTION POLARITY down DEFLECTION POLARITY up* DEFLECTION POLARITY center* DEFLECTION POLARITY down*
	1,5	Gnd.	+29	
	2	Gnd.	6.5AC	
	3	Gnd.	0	
	4	Gnd.	+13 to +23	
	6	Gnd.	+160	
	6	Gnd.	+195	
	6	Gnd.	+165	
	7	Gnd.	0	
	8	Gnd.	+190	
8	Gnd.	+150		
8	Gnd.	+110		
V19	1,5	Gnd.	+32	DEFLECTION POLARITY up and center DEFLECTION POLARITY down DEFLECTION POLARITY up 50 volt scale DEFLECTION POLARITY center 50 volt scale DEFLECTION POLARITY down 50 volt scale
	1,5	Gnd.	+29	
	2	Gnd.	6.5AC	
	3	Gnd.	0	
	4	Gnd.	+23	
	4	Gnd.	+20	
	4	Gnd.	+17.5	

*NOTE: Use a 100 k composition resistor at the end of the voltmeter probe to prevent error in reading due to oscillation which might otherwise result when the meter is connected.



Tube	Pin	To	Voltage	
V19	6	Gnd.	+160	DEFLECTION POLARITY up
	6	Gnd.	+195	DEFLECTION POLARITY center
	6	Gnd.	+165	DEFLECTION POLARITY down
	7	Gnd.	0	
	8	Gnd.	+110	DEFLECTION POLARITY up*
	8	Gnd.	+150	DEFLECTION POLARITY center*
	8	Gnd.	+200	DEFLECTION POLARITY down*
V20	1	Pin 14	6.5AC	
	2	Pin 14	+160	INTENSITY clockwise
	2	Pin 14	+80	INTENSITY counterclockwise
	3	Pin 14	+83	INTENSITY clockwise
V20	3	Pin 14	0	INTENSITY counterclockwise
	5	Gnd.	-750	FOCUS clockwise
	5	Gnd.	-1100	FOCUS counterclockwise
	7	Gnd.	0(+ or -40v)	SWEEP STABILITY counterclockwise---spot centered
	8	Gnd.	0(+ or -40v)	
	9	Gnd.	-140	ASTIGMATISM clockwise
	9	Gnd.	+225	ASTIGMATISM counterclockwise
	10	Gnd.	0(+ or -40v)	SWEEP STABILITY counterclockwise--spot centered
	11	Gnd.	0(+ or -40v)	
	V21	1	T1, term. 8	260 AC
2,3,7		Gnd.	+680	
4		V21, pin 3	6.5 AC	
6		T1, term. 8	260 AC	
V22	2	V22, pin 8	5.2 AC	
	4,6	Gnd.	280 AC	
	8	Gnd.	+325	
V23	2	V23 pin 8	5.2AC	
	4,6	Gnd.	280 AC	
	8	Gnd.	+325	
V24	1,6	Gnd.	-335	
	3	V24 pin 4	6.5AC	
	4,7	Gnd.	280 AC	
V25	1	+450	-18	
	2,3	Gnd.	+450	
	4	V25 term.3	6.5AC	
	5,6	Gnd.	+680	
V26	1	+225	-1.3	
	2,7	+225	0	
	3	V26 pin 4	6.5AC	
	5	+450	-18	
	6	+225	+46	

*NOTE: Use a 100 k composition resistor at the end of the voltmeter probe to prevent error in reading due to oscillation which might otherwise result when the meter is connected.



Tube	Pin	To	Voltage	
V27	1,4	+ 225	-38	
	2,5	Gnd.	+325	
	3,6	Gnd.	+225	
	7	Gnd.	6.5AC	
	8	Gnd.	0	
V28	1	Gnd.	+87	
	2,7	Gnd.	+89	
	3	Gnd.	0	
	4	Gnd.	6.5AC	
	5	+225	-38	
	6	Gnd.	+137	
V29	1	Gnd.	+89	
	4	Gnd.	0	
V30	2	Gnd.	-150	
	5	Gnd.	0	
V31	1,7	Gnd.	-2450 volt scale
	2	Gnd.	+2.5	
	3	Gnd.	0	
	4	Gnd.	6.5AC	
	5	Gnd.	+225	
	6	Gnd.	+165 Nominal
V32.1	4	Pin7	1.25AC	Measured with thermocouple meter
	5	Gnd.	+1600	
V33.1	2	Pin7	1.25AC	

POINT TO POINT TUBE SOCKET CONTINUITY

(Tubes in Sockets)

Beginning with S/N 845 and up. Readings are approximately the same for instruments S/N 101-845.

NOTE: Readings less than .1 ohm are listed 0.

Tube	Pin No.	To	Resistance
V1	1	Gnd.	0
	2	Gnd.	0
	3	Gnd.	1830 Ω
	4	Gnd.	470 k
	5	Gnd.	1830 Ω
	6	+225	4.7 k
	7	Gnd.	0
	8	+225	6.2 k



Tube	Pin No.	To.	Resistance	
V2	4	Gnd.	0	
	2	Gnd.	0	
	3	Gnd.	1000 Ω	
	4	Gnd.	470 k	TRIGGER AMPL. clockwise
			780 k	TRIGGER AMPL. counterclockwise
	5	Gnd.	1000 Ω	
	6	+ 225	0	
	7	Gnd.	0	
	8	+ 225	10 k	
V3	1	V2 pin 8	0	
	2	+ 225	10 k	
	3	Gnd.	0	
	4	Gnd.	0	
	5	V2 pin 8	0	
	6			
	7	+ 225	10 k	
V4	1	Gnd.	0	
	2	Gnd.	0	
	3	Gnd.	0	
	4	Gnd.	75 k	SWEEP STABILITY clockwise
	4	+ 225	75 k	SWEEP STABILITY clockwise
	5	Gnd.	0	
	6	Gnd.	10 k	
	6	+ 225	12 k	
7	Gnd.	0		
	8	+ 225	9.5 k	
V5	1	Gnd.	0	
	2	Gnd.	0	
	3	Gnd.	0	
	4	Gnd.	200 k	SWEEP SPEED MULT. clockwise (S/N 845-1405)
	4	Gnd.	200 k	SWEEP SPEED MULT. 1.0 (S/N 1406 and up)
	4	Gnd.	2.2 meg	SWEEP SPEED MULT. counterclockwise (S/N 845-1405)
	4	Gnd.	2.2 meg	SWEEP SPEED MULT. 10.9 (S/N 1406 and up)
	5	Gnd.	0	
	6	Gnd.	10 k	
	6	+ 225	12 k	
	7	Gnd.	0	
	8	+ 225	4.5 k	
	8	V4 pin 4	80 k	
(S/N 845-2868)				
V6	1	Gnd.	35 meg	
	1	V11 pin 6	470 Ω	
	2	-140	85 k	
	2	V5 pin 8	78 k	
	3	Gnd.	0	
	4	Gnd.	0	
	5	Gnd.	14 k	
	5	+ 225	20 k	
6				
7	Gnd.	0		



Tube	Pin No.	To	Resistance
(S/N2869 and up)			
V6	1,5	-140	35 meg
	2,3,7	Gnd.	0
	4	Gnd.	0
(S/N845-2868)			
V7	1		
	2		
	3	Gnd.	0
	4	Gnd.	0
	5	+ 225	0
	6	V6 pin 2	0
	7	Gnd.	10 k
(S/N2869 and up)			
V7.1	1,7	+ 225	14.7 k
A,B	2	-140	65 k
	2	+ 225	70 k
	3,4,5	Gnd.	0
	6	+ 450	0
	8	Gnd.	47 k
V8	1	+ 225	10 k
	2		
	3	Gnd.	0
	4	Gnd.	0
	5		
	6	Gnd.	250 k
	7	Gnd.	10 k
V9	1	Gnd.	0
	2	Gnd.	0
	3	Gnd.	0
	4	-140	65 k
	4	+ 225	70 k
	5	Gnd.	0
	6	+ 225	20 k
	7	Gnd.	0
8	Gnd.	infinite	
V10	1		
	2		
	3	Gnd.	0
	4	Gnd.	0
	5	+ 225	0
	6	V9 pin 8	0
	7	Gnd.	10 k
V11	1	+ 225	10 k
	2	+ 225	14.7 k
	3	Gnd.	0
	4	Gnd.	0
	5	Gnd.	8.2 k
	6	Gnd.	35 meg

SWEEP MAGNIFIER POSITION out



Tube	Pin No.	To	Resistance	
V12	1,5	Gnd.	35 meg	
	2,3	Gnd.	0	
	4	Gnd.	0	
	6			
	7	Gnd.	0	
V13	1	V12 pin 5	180 Ω	
	2,7	-140	11 k	
	2,7	V14 pin 2	900 Ω	
	3	Gnd.	0	
	4	Gnd.	0	
	5,6	+450	25 k	
V14	1	Gnd.	0	HOR. POSITION clockwise
	1	Gnd.	90 k	HOR. POSITION counterclockwise
	2,7	-140	11 k	
	3	Gnd.	0	
	4	Gnd.	0	
	5,6	+450	25 k	
V15	1	+450	0	
	2			
	3	+450	.2 Ω	
	4	+450	0	
	5	+450	0	
	6	+450	240 to 480 k	depending on setting of R42
	6	+450	0	with SWEEP RANGE set at 1 microsec.
	7	V9 pin 8	200 k	SWEEP SPEED MULT. clockwise (S/N 845-1405)
	7	V9 pin 8	200 k	SWEEP SPEED MULT. 1.0 (S/N 1406 and up)
	7	V9 pin 8	2.2 meg	SWEEP SPEED MULT. counterclockwise (S/N 845-1405)
7	V9 pin 8	2.2 meg	SWEEP SPEED MULT. 10.9 (S/N 1406 and up)	
V16	1,3			
	2	Gnd.	0	
	4	Gnd.	1 meg	
	5,7	Gnd.	0	
	6	+225	10 k	
	8	+225	3.2 k	
(S/N2406 and up)				
V16.1	1	450	0	
	2,6,7	T1 term.16	11 meg	
	3	Gnd.	20.55 k	SIGNAL-CALIBRATE switch in SIGNAL position
	3	Gnd.	10 k	SIGNAL-CALIBRATE switch in 100 v position
	4,5	Gnd.	0	
	8	Gnd.	22 k	
	9	Gnd.	0	
V17	1,3,5	Gnd.	2 k	
	2	Gnd.	0	
	4	Gnd.	1 meg	INPUT CHAN. SEL. set at 1 STAGE
	6	+225	0	
	7	Gnd.	0	
	8	+225	1.5 k	



Tube	Pin No.	To	Resistance	
V18	1,5	Gnd.	440 Ω	
	2	Gnd.	0	
	3,7	Gnd.	0	
	4	Gnd.	290 k	R116 counterclockwise
	4	Gnd.	1.3 meg	R116 clockwise
	6	+225	2.2 k	S9 in center position
	6	+225	4.4 k	S9 in up or down position
	8	+225	2.8 k	
V19	1,5	V18 pin 1	0	
	2	Gnd.	0	
	3,7	Gnd.	0	
	4	Gnd.	470 k	
	6	V18 pin 6	0	
	8	+225	2.8 k	
V20	1	T1 term.25	0	
	1	Gnd.	9 meg	
	2	V20 pin 1	500 k	
	3	V20 pin 1	2 meg	INTENSITY control clockwise
	3	V20 pin 1	1.5 meg	INTENSITY control counterclockwise
	5	V20 pin 1	3.5 meg	FOCUS control clockwise
	5	V20 pin 1	1.9 meg	FOCUS control counterclockwise
	7	Y2 access panel	0	
	8	Y1 access panel	0	
	9	-140	0	ASTIGMATISM control clockwise
	9	+225	0	ASTIGMATISM control counterclockwise
	10	X2 access panel	0	
	11	X1 access panel	0	
	14	V20 pin 1	.2 Ω	
V21	1	T1 term. 7	0	
	2,3,7	T1 term. 11	0	
	4	T1 term. 10	0	
	6	T1 term. 9	0	
V22	2	T1 term. 13	0	
	4,6	T1 term. 14	0	
	8	+225	1 k	
V23	2	V22 pin 2	0	
	4,6	T1 term. 16	0	
	8	V22 pin 8	0	
V24	1,6	-140	4.5 k	
	3	T1 term. 17	0	
	4,7	T1 term. 16	0	
V25	1	V25 pin 5	470 k	
	2,3	T1 term. 6	0	



Tube	Pin No.	To	Resistance
V25 (cont.)	4	+450	0
	5,6	V21 pin 7	0
V26	1	Gnd.	550 k
	2,7	+225	0
	3	T1 term. 22	0
	4	T1 term. 23	0
	5	V25 pin 1	0
	6	+225	43 k
	6	+450	130 k
V27	1,4	V22 pin 8	470 k
	2,5	+225	1 k
	3,6	+225	0
	7	Gnd.	0
	8	Gnd.	0
V28	1	Gnd.	630 k with R159 set at midpoint
	2,7	+225	74 k
	3	Gnd.	0
	4	Gnd.	0
	5	V27 pin 4	0
	6	+225	47 k
V29	1	V28 pin 2	0
	4	Gnd.	0
V30	1,5	Gnd.	0
	2	-140	470 Ω
V31	1	Gnd.	100 k
	2	Gnd.	100 Ω
	3	Gnd.	0
	4	Gnd.	0
	5	+225	160 Ω
	6	+225	15 k (S/N 845-2699)
	6	+225	10 k to 20 k depending on setting of R165.2 (S/N 2700 and up)
V32	1,3,4		
	5,6,7		
	8	Gnd.	50 meg
	2	V 32 pin 1	.1 Ω
	Cap	V33 pin 3	0
V33	1,3,4,5,		
	6,7,8	Gnd.	1.3 k
	2	V33 pin 1	.1 Ω
	Cap	Gnd.	9 meg



TRANSFORMER CONTINUITY

T1 (Measured with leads disconnected)

Terminals Ohms Resistance (20°C)

1 to 3	1.7
2 to 4	1.7
5 to 6	.3
7 to 8	147.
8 to 9	150.
10 to 11	.27
12 to 13	.03
14 to 15	10.8
15 to 16	10.9
16 to 17	.21
18 to 19	.025
20 to 21	6.1
22 to 23	.42
24 to 25	.25

T2 (Measured with V32 and V33 removed from sockets)

From	To	Ohms Resistance 20°C)
V31 pin 5	+ 225	15.3
Junction C74,C75	+ 225	2.8
V32 pin 2	V32 pin 7	.03
V33 pin 2	V33 pin 7	.03
V33 pin 7	Gnd.	1175.

WAVEFORMS

Beginning with S/N 845 and up. Waveforms will apply to instruments S/N 101-845 in most cases.

The following photographs are provided to facilitate servicing of the Type 511A and will prove especially useful if another oscilloscope is available to observe the waveforms of the circuits being tested. Amplitudes are measured peak-to-peak.

CAUTION--These waveforms and amplitudes represent average values, selected from a number of instruments.

Considerable normal variation in individual oscilloscopes may be expected, due to a variety of causes, such as:

1. Loading effect of the test oscilloscope.
2. Non-linearity of the test oscilloscope.
3. Insufficient bandwidth of the test oscilloscope.
4. Manufacturing tolerances of the components in the Type 511A under test.
5. Variations in control settings of the 511A under test.
6. Line voltage variations.



DEFLECTION POLARITY SELECTOR WAVEFORMS

Normal operation of this circuit for observation of pulses is shown in the following photographs. The sawtooth pulse has a duration of 1 millisecond and a 60 cycle repetition rate.

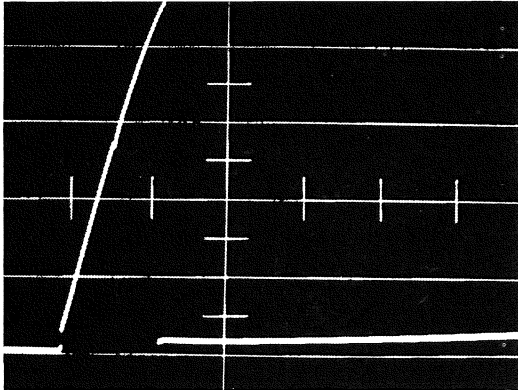

Fig. 4-1. Sawtooth pulse with DEFLECTION POLARITY switch in the "up" position, showing good linearity at 4 cm deflection. A "step" has been introduced for comparison between the "up" and "center" positions.

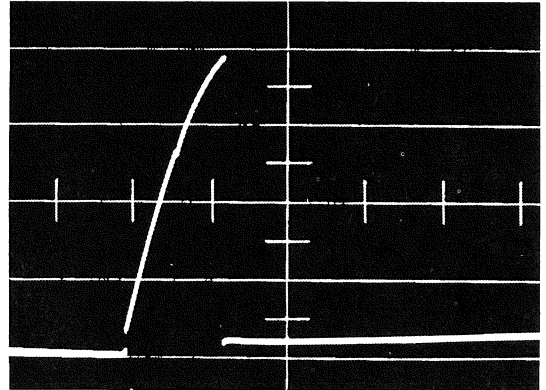

Fig. 4-2. Same pulse with DEFLECTION POLARITY switch in "center" position. Note that position of the step is unchanged, indicating good linearity for almost 3 cm. of deflection, but severe distortion between 3 and 4 cm.

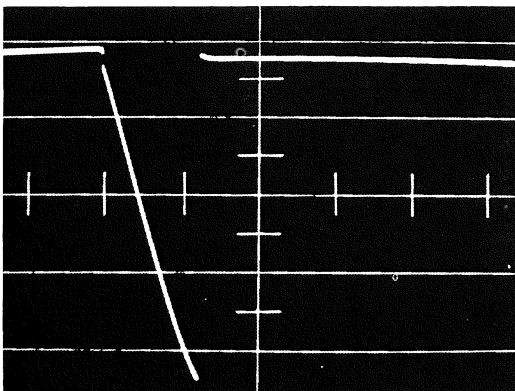

Fig. 4-3. Sawtooth pulse of opposite polarity with DEFLECTION POLARITY switch in the "down" position.

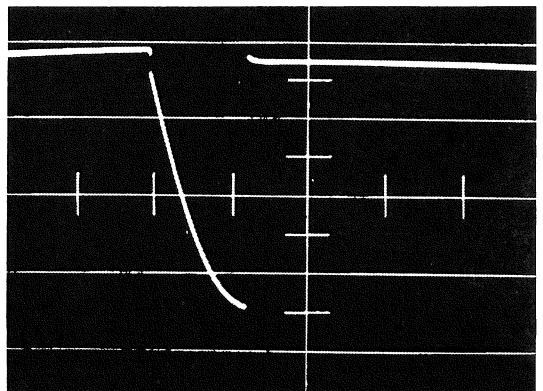

Fig. 4-4. Same pulse with DEFLECTION POLARITY switch in the "center" position.



POWER SUPPLY WAVEFORMS

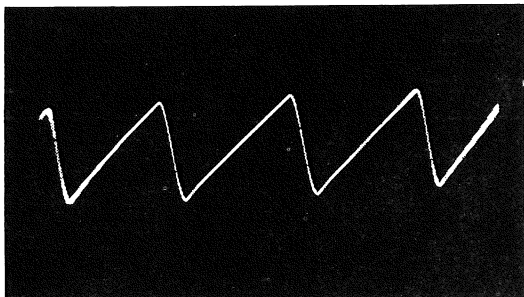

Fig. 4-5 60-cycle ripple of -140 volt rectifier output at V24 plate. Amplitude 12 volts.

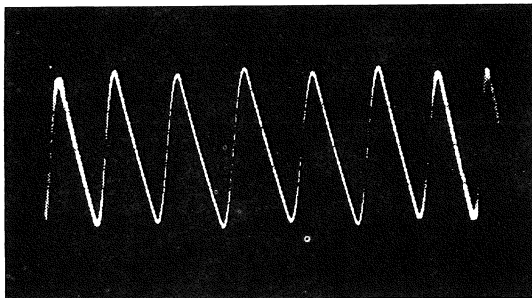

Fig. 4-6. 120-cycle ripple of +225 volt rectifier output at V22 cathode and +450-volt rectifier output at V21 cathode. Amplitude 15 volts.

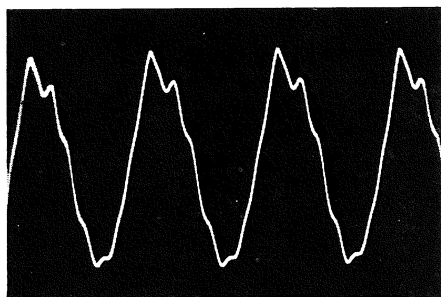

Fig. 4-7. High-voltage supply oscillator waveform at V31 grid. Amplitude 75 volts.

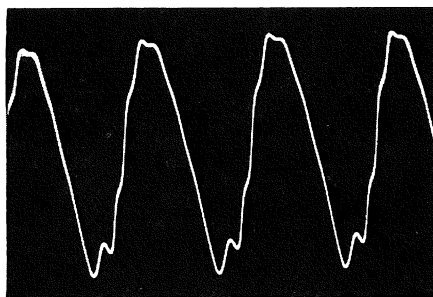

Fig. 4-8. Waveform at V31 plate. Amplitude 350 volts.

SWEEP AND TRIGGER CIRCUIT WAVEFORMS

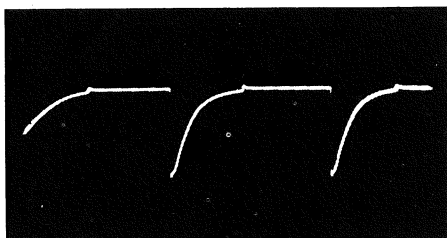

Fig. 4-9. Multivibrator waveform at V4 grid, with controls set for 10 μ sec recurrent sweep. Amplitude 70 volts.

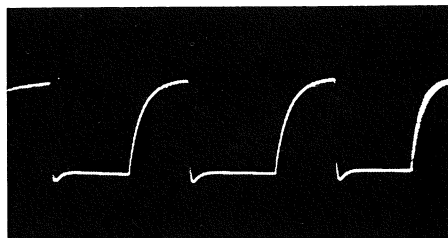

Fig. 4-10. Multivibrator waveform at V4 plate, controls set for 10 μ sec recurrent sweep. Amplitude 120 volts.



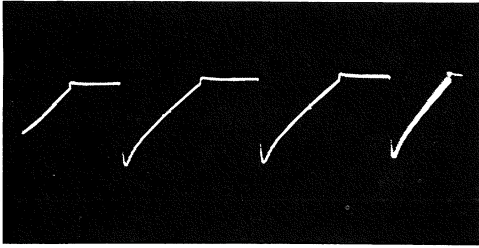

Fig. 4-11. Multivibrator waveform at V5 grid, controls set for 10 μ sec recurrent sweep. Amplitude 85 volts.

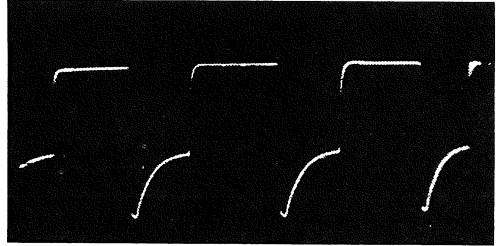

Fig. 4-12. Multivibrator waveform at V5 plate, controls set for 10 μ sec recurrent sweep. Amplitude 160 volts.

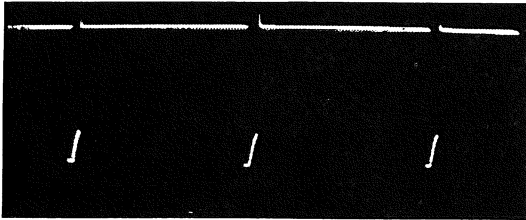

Fig. 4-13. Waveform at +GATE, controls set for 1000 μ sec recurrent sweep. Amplitude 45 volts.

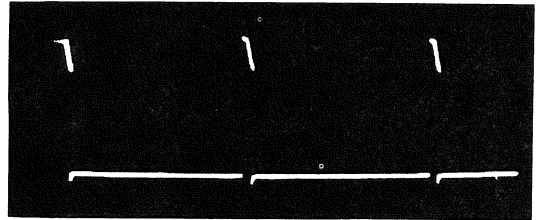

Fig. 4-14. Waveform at -GATE, controls set for 1000 μ sec recurrent sweep. Amplitude 45 volts.

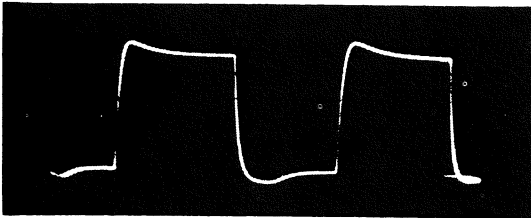

Fig. 4-15. +GATE, controls set for 10 μ sec recurrent sweep. Amplitude 45 volts.

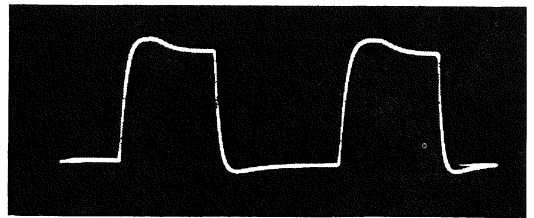

Fig. 4-16. -GATE, controls set for 10 μ sec recurrent sweep. Amplitude 45 volts.

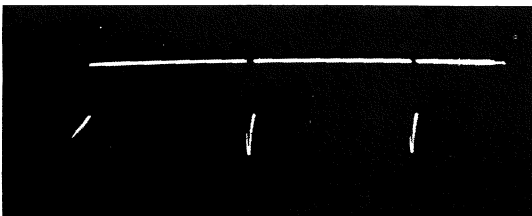

Fig. 4-17. Unblanking pulse at V7 cathode, 1000 μ sec recurrent sweep. Amplitude 70 volts.

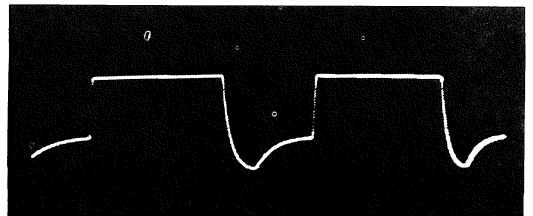

Fig. 4-18. Unblanking pulse at V7 cathode, 10 μ sec recurrent sweep. Amplitude 65 volts.



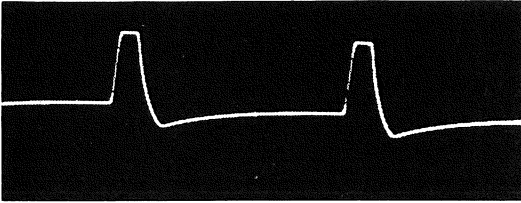

Fig. 4-19. Unblanking pulse at V7 cathode, 1 μ sec recurrent sweep. Amplitude 65 volts.

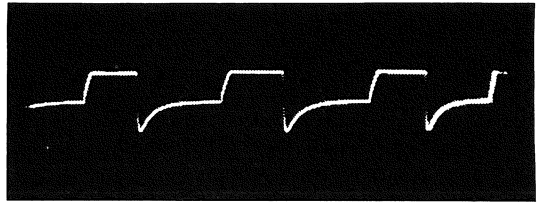

Fig. 4-20. Waveform at V9 grid, 10 μ sec recurrent sweep. Amplitude 50 volts. Exposure made under same conditions as figures 4-8, 4-9, 4-10, and 4-11.

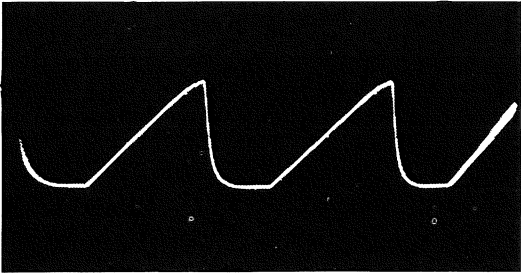

Fig. 4-21. Sweep sawtooth at V9 plate, 10 μ sec recurrent sweep. Amplitude 35 volts. This waveform also appears at the SWEEP OUTPUT binding post at an amplitude of 25 volts.

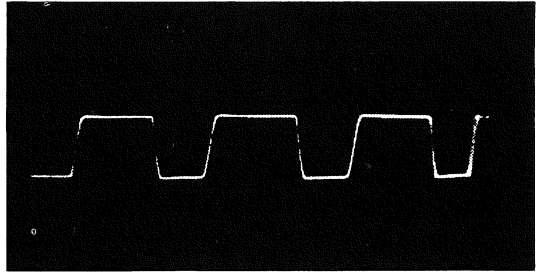

Fig. 4-22. Magnified sweep waveform at V11 plate, showing the 10 μ sec recurrent sweep of Fig. 4-20 magnified 5X. Amplitude 25 volts.

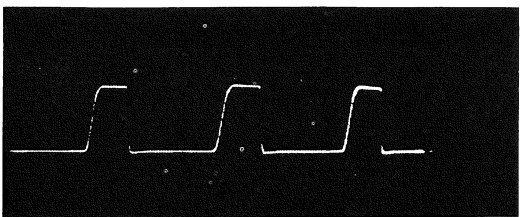

Fig. 4-23. Same as Fig. 4-21, except with a different setting of SWEEP MAGNIFIER POSITION control. Amplitude 30 volts.

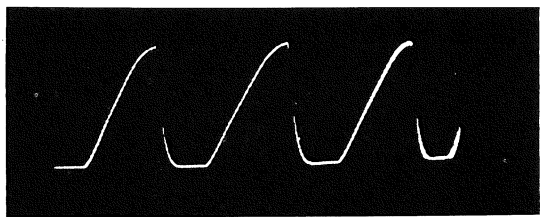

Fig. 4-24. Amplified sweep sawtooth at X1 deflection plate, 10 μ sec recurrent sweep. Amplitude 200 volts.

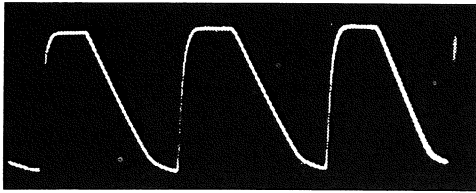

Fig. 4-25. Amplified sweep sawtooth of X2 deflection plate, 10 μ sec recurrent sweep. Amplitude 200 volts.

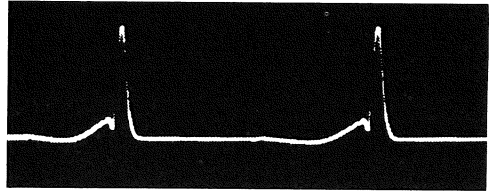

Fig. 4-26. 1 μ sec negative pulse at V1 grid from either video amplifier or TRIGGER INPUT. Amplitude .5 volt.

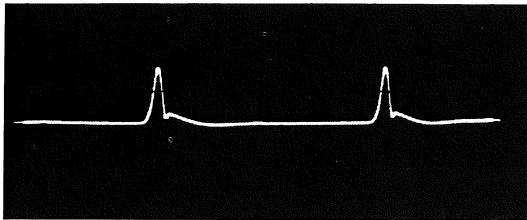

Fig. 4-27. The same pulse at V2 grid. Negative Trigger polarity. Amplitude .25 volt.

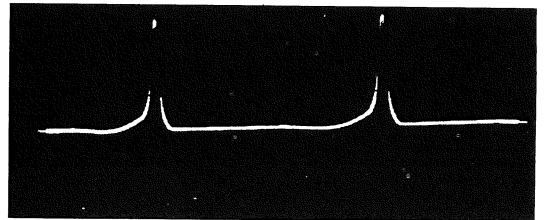

Fig. 4-28. The same pulse, amplified, at V2 plate. Amplitude 5 volts.

VIDEO AMPLIFIER WAVEFORMS

These photographs should be used in conjunction with the Adjustment section of this manual during adjustment of the video amplifier.

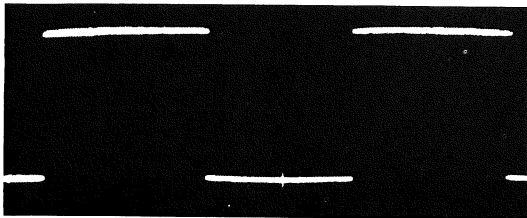

Fig. 4-29. Normal response to a 50-cycle square wave.

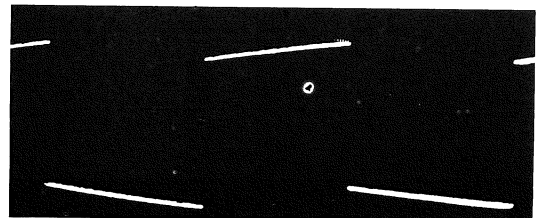

Fig. 4-30. Response to 50 cycle square wave when low-frequency compensation is excessive, indicating need for adjustment of R99 and/or R116.



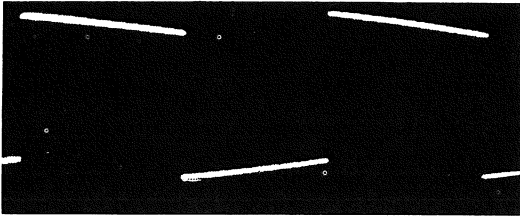

Fig. 4-31. Response to 50-cycle square wave when low-frequency compensation is insufficient, also indicating need for L.F. adjustment.

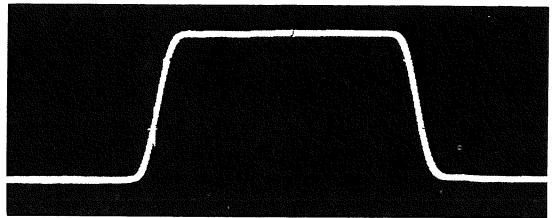

Fig. 4-32. Normal response to 1 megacycle square wave.

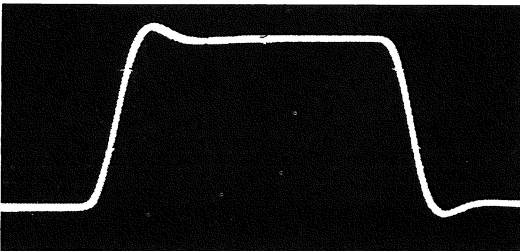

Fig. 4-33. Response to 1 megacycle square wave showing overshoot due to excessive high-frequency compensation. Re-adjustment is indicated.

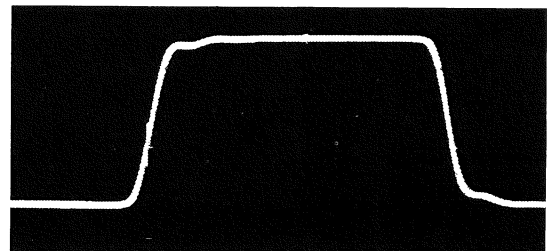

Fig. 4-34. Response to a 1 megacycle square wave showing the effect of insufficient high-frequency compensation.

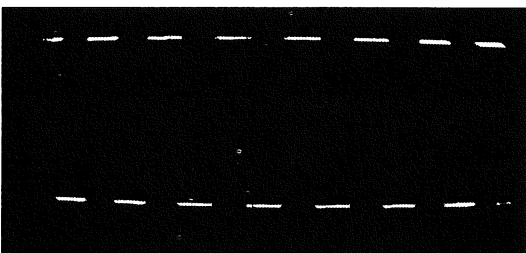

Fig. 4-35. Normal response to 1 kilocycle square wave.

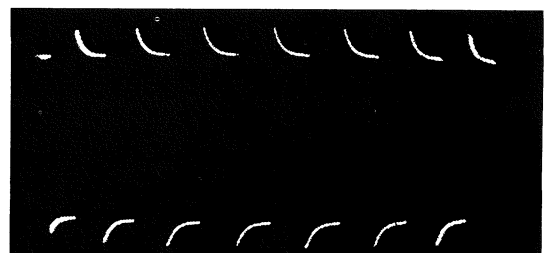

Fig. 4-36. Response to 1 kilocycle square wave with the input attenuator or probe over-compensated.



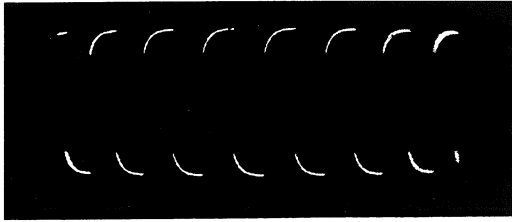

Fig. 4-37. Response to 1 kilocycle square wave with the input attenuator or probe under compensated.

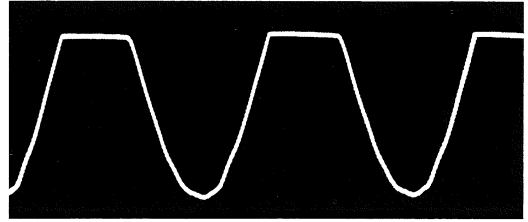

Fig. 4-38. Positively clipped sine wave at pins 2, 6, and 7 of Calibrator Limiter, V16.1. Amplitude approximately 300 volts depending upon line voltage. (S/N 2406 and up).

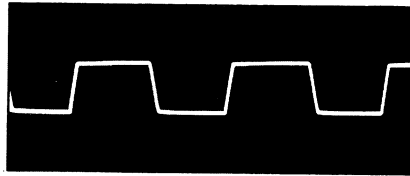

Fig. 4-39. Positively and negatively clipped sine wave at pin 3 of Calibrator Limiter, V16.1 Amplitude 100 volts as set by potentiometer R75.4, CAL. ADJ. (S/N 2406 and up).



SECTION 5

ADJUSTMENTS

OPERATION ON 210-250 VOLT LINE (S/N 455 and up)

The power transformer of the Type 511A is wound with two 115 volt primaries. When the instrument leaves the factory the primaries are ordinarily connected in parallel for 105-125 volt operation. If operation from 210-250 volt lines is desired remove the jumpers connecting terminals 1 to 2 and 3 to 4. Now connect terminals 2 and 3 together. With the line still connected to terminals 1 and 4 the instrument is ready for 210-250 volt operation.

ADJUSTMENT OF 225 VOLT REGULATED SUPPLY (S/N 455 and up).

In order for the instrument to perform properly it is necessary that the 225 volt supply be within plus or minus 5 volts of that value. This should be checked with an accurate voltmeter and corrected if necessary by adjustment of the potentiometer R159 on the power supply chassis marked ADJ TO 225 V. This check should always be made if the 5651 tube V29 is changed.

ADJUSTMENT OF 225 VOLT REGULATED SUPPLY (S/N 101-454)

In order for the instrument to perform properly it is necessary that the 225 volt supply be within plus or minus 5 volts of that value. This should be checked with an accurate voltmeter and corrected if necessary by adjustment of the potentiometer R167 on the power supply chassis marked ADJ to 225 V. This check should always be made if the VR105 tube V28 is changed.

ADJUSTMENT OF HIGH-VOLTAGE SUPPLY (S/N 2700 and up).

The -1500 volt supply should be set to within 10% of this value. This is accomplished by varying the screen potential of the oscillator V31 by means of the variable resistor R165.2. After making this adjustment always check sweep speed timing for accuracy and reset if necessary.

ADJUSTMENT OF SWEEP-SPEED CALIBRATION

If the Cathode-Ray Tube is replaced, or if the Sweep Amplifier tubes V13 and V14 change their characteristics, the indicated sweep speeds may be in error. This may be corrected by adjustment of the potentiometer on the chassis marked SWEEP SPEED ADJ. (R42), for all ranges except the 1 to 10 microsecond range, which is corrected by varying C15A located on the rear section of the Sweep Range Switch.

These adjustments may be made with the aid of an accurately calibrated oscillator. A commonly available instrument suitable for this purpose is the Army Frequency Meter BC 221, or the Navy equivalent, Type LM. If this type instrument is used, set the frequency at 200 KC and connect it to the Type 511A SIGNAL INPUT.

With the SWEEP SPEED MULT. dials at 1.0 and the SWEEP RANGE switch at 10 microseconds, adjust R42 until 2 cycles coincide with the 10 cm scale. Change the frequency meter setting to 2 mc, set the SWEEP SPEED MULT. dials at 2.0 and the SWEEP RANGE switch at 1 microsecond and adjust C15A until 4 cycles occupy the 10 cm scale.

CAUTION-USE NORMAL INTENSITY, AS THE CRT DEFLECTION SENSITIVITY INCREASES AT MAXIMUM INTENSITY. USE THE MINIMUM TRIGGER AMPL. SETTING CONSISTENT WITH A STABLE PATTERN.

ADJUSTMENT OF INPUT ATTENUATOR

The RC compensated attenuator used in the Type 511A is really two attenuators in parallel, one a resistive divider and the other a capacity divider. The ratio of the resistive divider is maintained by the use of accurate resistors. Since the stray capacities are not negligible compared to the values used in the capacity divider, each divider incorporates a variable ceramic trimmer capacitor in one arm. To make the input capacity of each amplifier and that of the attenuator equal, similar capacitors



are shunted across these circuits also.

The easiest way to make these adjustments is to send a square wave through the attenuator and observe the resulting waveshape on the oscilloscope itself. When the capacity and resistive dividers have the same ratio the square wave is reproduced correctly. If the capacity divider has a lower attenuation ratio than the resistive divider a spike appears on the corners. If the capacity divider has a higher attenuation, the corners are rounded. To make these effects more pronounced the square wave frequency should be such that one cycle is from 4 to 20 times the time constant of the attenuator. In the case of the Type 511A a frequency of 1000 cycles is satisfactory. The amplitude of the square wave test signal should be adjustable from 1 to 50 volts (peak-to-peak).

The Tektronix Type 104A and Type 105 Square Wave Generators are suitable for this purpose. If a Tektronix Oscilloscope is available, its square wave calibrator may be used.

A procedure which has proven satisfactory is as follows:

1. Lay a metal sheet on top of the instrument to simulate the presence of the case.
2. Apply a 50 v square wave to the Signal Input connector, set the INPUT CHAN. SEL. to VIA COND., the INPUT ATTENUATOR to X2, and adjust C37 (left rear on attenuator).
3. Reduce the square wave amplitude to 10 v, move the INPUT CHAN. SEL. to 1 STAGE, and adjust C42 (left on Input Chan. Sel.).
4. Move INPUT ATTEN. to X4, increase square wave to 20 v, and adjust C34 (center rear on attenuator).
5. Move INPUT ATTEN. to X8, increase square wave to 40 v, and adjust C31 (right rear on attenuator).
6. Reduce the square wave amplitude to 1 v, move the INPUT CHAN. SEL. to 2 STAGES, INPUT ATTEN. to X2, and adjust C44 (right on input chan. sel.).
7. (S/N 455 and up). Move square wave signal from SIGNAL INPUT to the probe, apply a 5 v signal, set INPUT ATTEN to X1, and adjust

the probe compensating capacitor.

7. (S/N 101-454). Move square signal from SIGNAL INPUT TO ATTEN. 5X, apply a 2.5 v signal, set INPUT ATTEN. to X1, and adjust C30 (between Input and Atten. 5X binding posts).
8. Move INPUT ATTEN. to X2 and adjust C38 (left front on attenuator), using a 10 v (5 v, S/N 101-454) signal.
9. Move INPUT ATTEN. to X4 and adjust C35 (center front on attenuator), using a 25 v (10 v, S/N-101-454) signal.
10. Move INPUT ATTEN. to X8 and adjust C32 (right front on attenuator), using a 50 v (25 v, S/N 101-454) signal.

ADJUSTMENT OF VERTICAL AMPLIFIER H.F. RESPONSE

The video amplifier in the Type 511A employs a four terminal coupling network which is adjusted at the factory for optimum transient response, rather than flattest frequency response. This is done by observing the response to a 1 mc square wave having a risetime of .03 microseconds or less. This test signal should have squarest possible corners and a minimum of overshoot so that the oscilloscope compensation adjustments are not inadvertently used to correct for these deficiencies.

The Tektronix Type 104A and Type 105 Square Wave Generators provide a suitable signal.

Since the image on the tube is the resultant deflection of both sides of the push-pull amplifiers, V18 and V19, the adjustment of the compensating coils is somewhat interdependent. The factory procedure which gives the flattest frequency response consistent with satisfactory transient response is as follows:

1. Set all cores in the compensating coils for minimum inductance.
2. Place INPUT CHAN. SEL. in 1 STAGE position and set VERT. AMPL. ATTEN. for maximum gain.
3. Apply 1 mc square wave of such amplitude that about 2 to 3 cm deflection is obtained (INPUT ATTENUATOR may be in any position).



4. Increase the inductance of L8 until a slight overshoot appears.
5. Adjust L7 and L9 (readjust L8 slightly if necessary) so that the best compromise is obtained between squareness of the corners and flatness of the level portion is obtained.
6. If it is not possible to obtain a satisfactory wave shape, increase the inductance of L10 and repeat steps 4 and 5.
7. Move the INPUT CHAN. SEL. to 2 STAGES, and readjust the amplitude of the input signal for the same deflection as before.
8. Adjust L4 and L5 for best waveshape.

The bandwidth may now be measured if desired. For the 1 STAGE position the response should be flat to about 5 mc, sloping gradually to be 2.5 to 3 db down at 10 mc. For 2 STAGES the curve is similar except falling somewhat more steeply, being 2.5 to 3 db down at about 8.5 mc.

ADJUSTMENT OF VERTICAL AMPLIFIER L.F. RESPONSE

Since the low-frequency compensation circuit of the Type 511A necessarily involves the use of electrolytic condensers, it may be occasionally necessary to correct for a change in their capacity. This is easily done by observing the response to a low-frequency square wave (30-60 cycles) and making the following adjustments:

1. With the INPUT CHAN. SEL. at 1 STAGE, adjust R116 (the rear LF ADJ) so that the best waveshape is obtained.
2. Move to the 2 STAGES position and adjust R99 (the front LF ADJ).

BE SURE THE AMPLIFIER
IS NOT OVERLOADED.

For a standard of comparison, observe the square wave reproduction with the INPUT CHAN.

SEL. in the DIRECT position. The Tektronix Type 104A and Type 105 Square Wave Generators provide a suitable signal source for this adjustment.

NOTE: The calibrating waveform may be used in making the L.F. adjustments when a suitable square wave generator is not available.

ADJUSTMENT OF CALIBRATOR VOLTAGE (S/N 2406 and up)

In order that the clipped sine-wave calibrating voltage as indicated upon the front panel be accurate, it is necessary that the CAL. VOLTAGE pointer knob be set mechanically at the minimum and electrically at the maximum setting of the CAL. VOLTAGE dial on the front panel. The mechanical adjustment must always be made first. This is accomplished by setting the INPUT CHAN. SEL. at 2 STAGES, the INPUT ATTENUATOR at X1, the SIGNAL-CALIBRATE switch at 100 v, and the CAL. VOLTAGE control fully counterclockwise. Slowly advance the CAL. VOLTAGE control until deflection just becomes apparent upon the face of the cathode-ray tube. At this point the pointer of the knob should agree with the zero mark on the front panel. If it does not, loosen the set screw and rotate the knob on the shaft until they are in agreement. Tighten the set screw and then proceed with the electrical adjustment. With the INPUT CHAN. SEL. in the DIRECT position, connect a 90 volt B battery to the SIGNAL INPUT and note the deflection of the CRT trace. Measure the battery voltage with an accurate 100 v scale DC voltmeter. Rotate the SIGNAL-CALIBRATE switch knob to 100 v and the CAL. VOLTAGE control to the voltmeter reading. Adjust CAL. ADJ. potentiometer R75.4 for the same deflection as given by the battery.

NOTE-Before making the above adjustments be sure that the 12AT7 tube, V16.1, is good and also that vertical amplifier has been adjusted as given under ADJUSTMENT OF VERTICAL AMPLIFIER L.F. RESPONSE.



The following available photographs cover instrument S/N 845 and up, the P510 probe and the P510A probe. Instruments S/N 101-845 are similar in appearance and these photographs will serve as a useful maintenance aid.

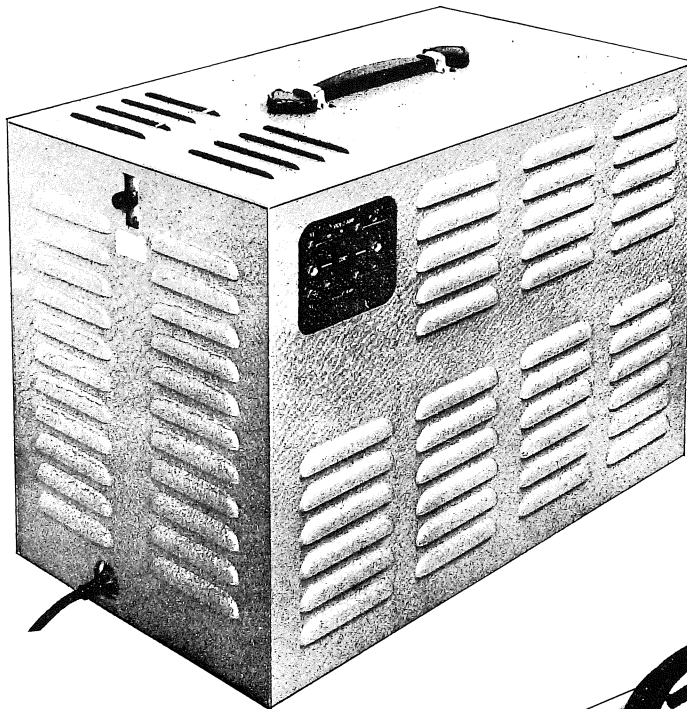

Fig. 5-1. Rear—left view (S/N 845-4226). S/N 4227 and up----- Change from 1 to 2 handles, parallel to front panel.

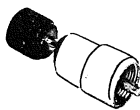

Fig. 5-2. Binding Post Adapter.

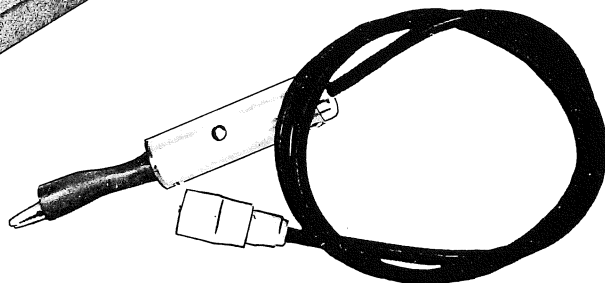

Fig. 5-3. P510 Input Probe.

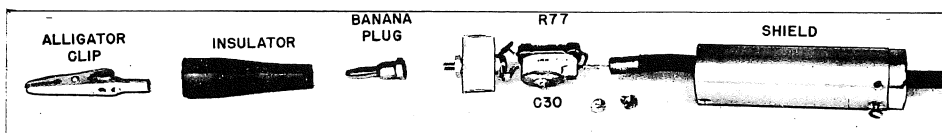
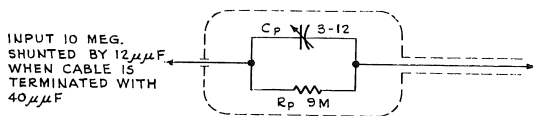
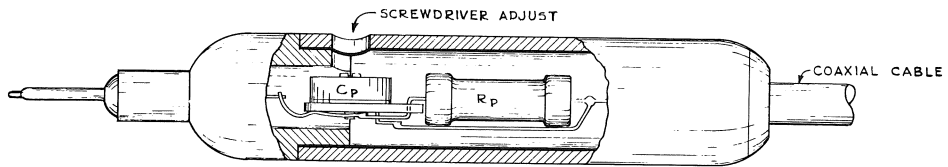

Fig. 5-4. P510 Input Probe disassembled.



INPUT 10 MEG.
SHUNTED BY $12\mu\mu\text{F}$
WHEN CABLE IS
TERMINATED WITH
 $40\mu\mu\text{F}$

C_p 3-12 $\mu\mu\text{F}$ CER. VAR. 500V
 R_p 9 MEG. 1W FIXED PREC. 1%

RBH
1-13-55

TEKTRONIX TYPE P510A PROBE

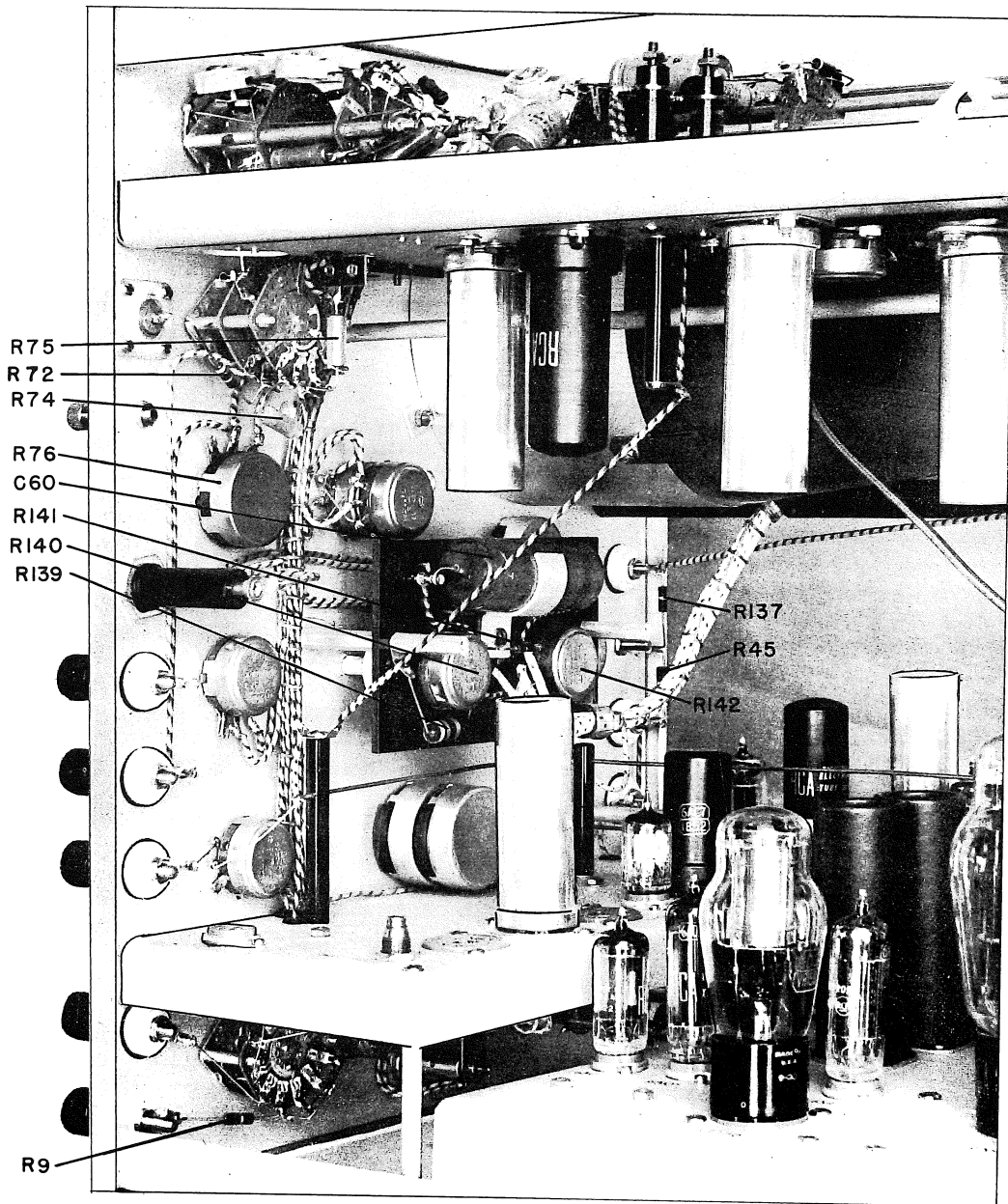
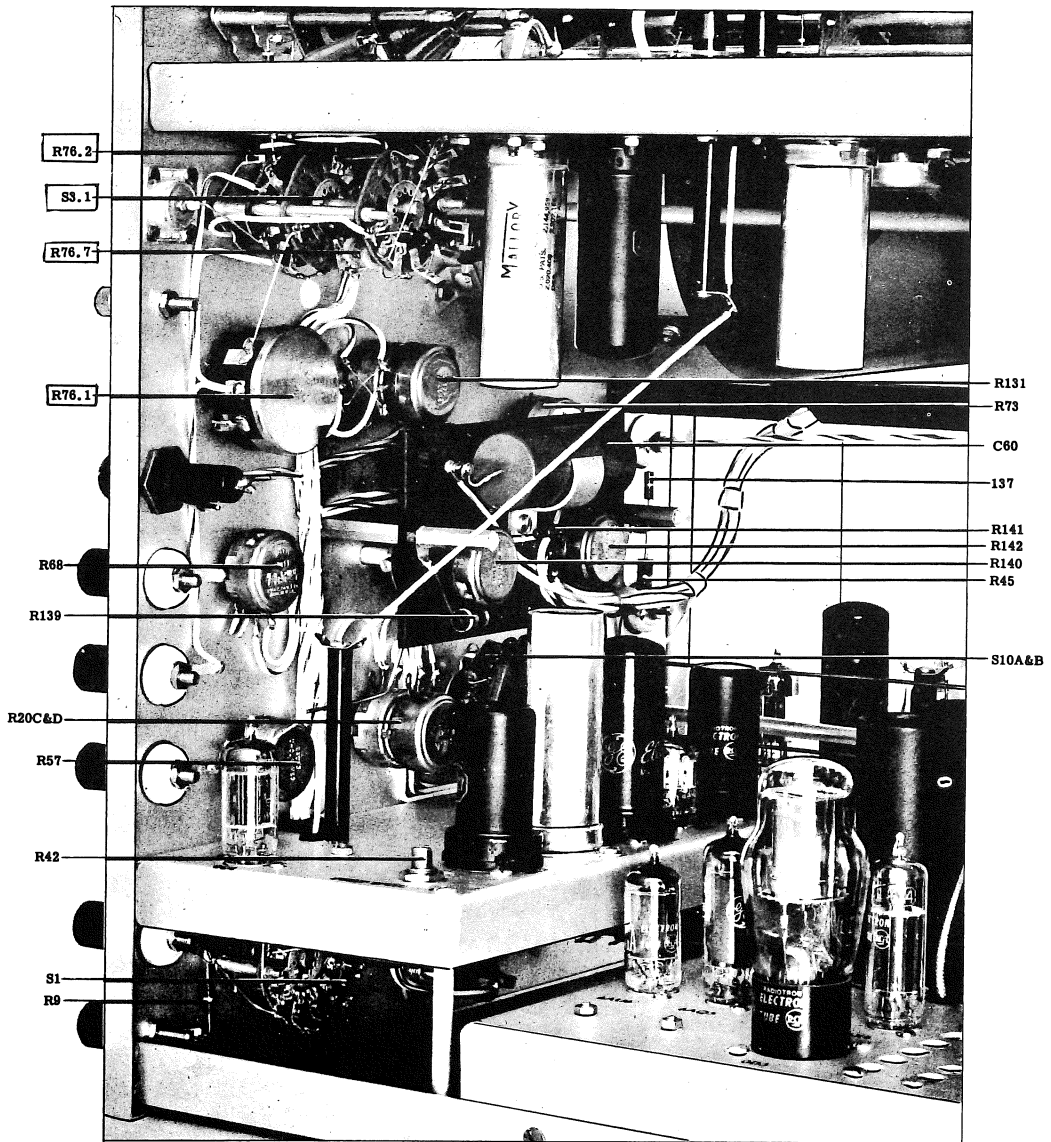

Fig. 5-6. Interior view, right front side. (S/N 845-1405)



NOTE: Picture is applicable to S/N1406 and up. Changes and additions made after S/N1406 are indicated by boxed circuit numbers. See parts list for effective serial numbers.

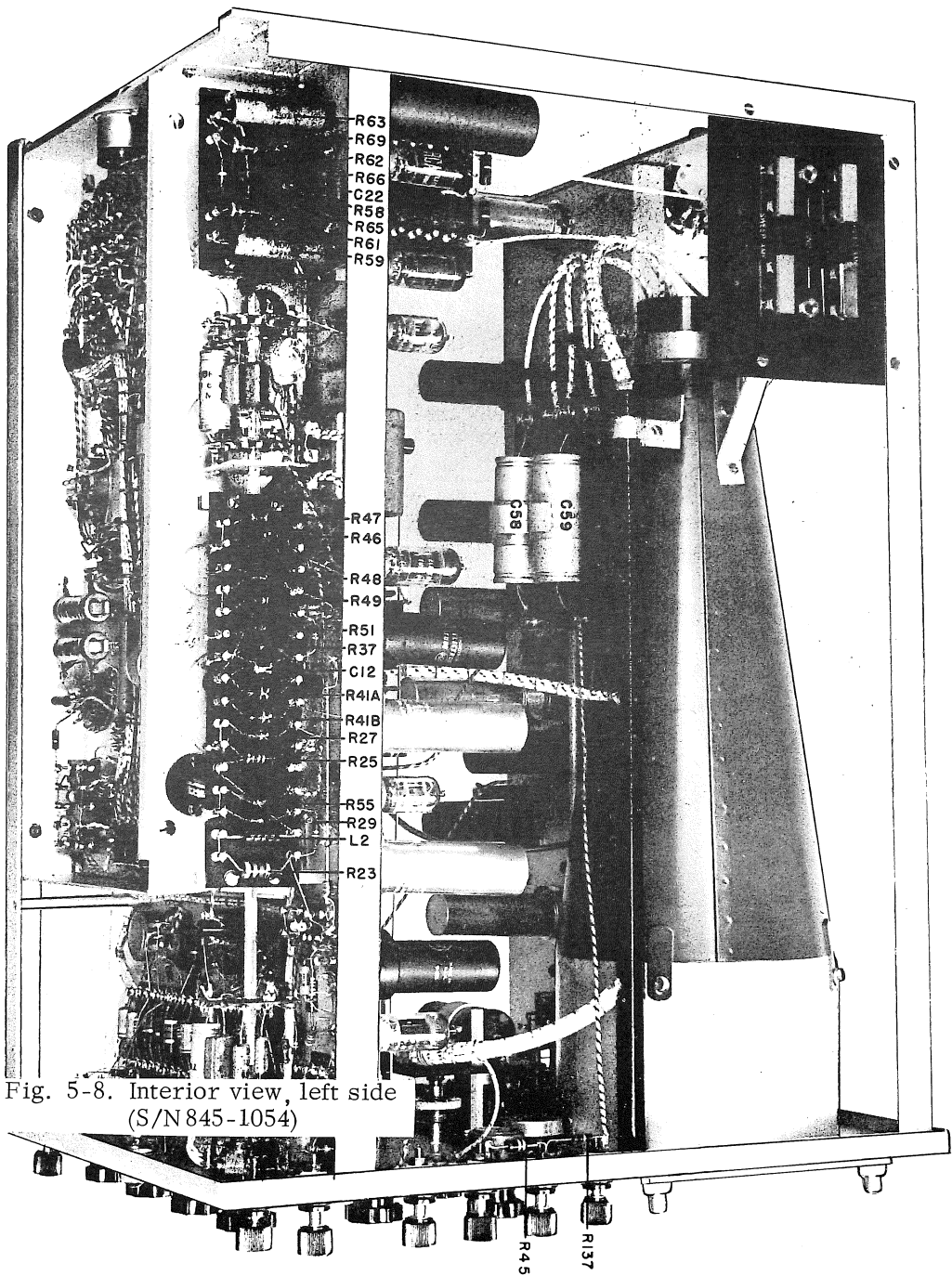
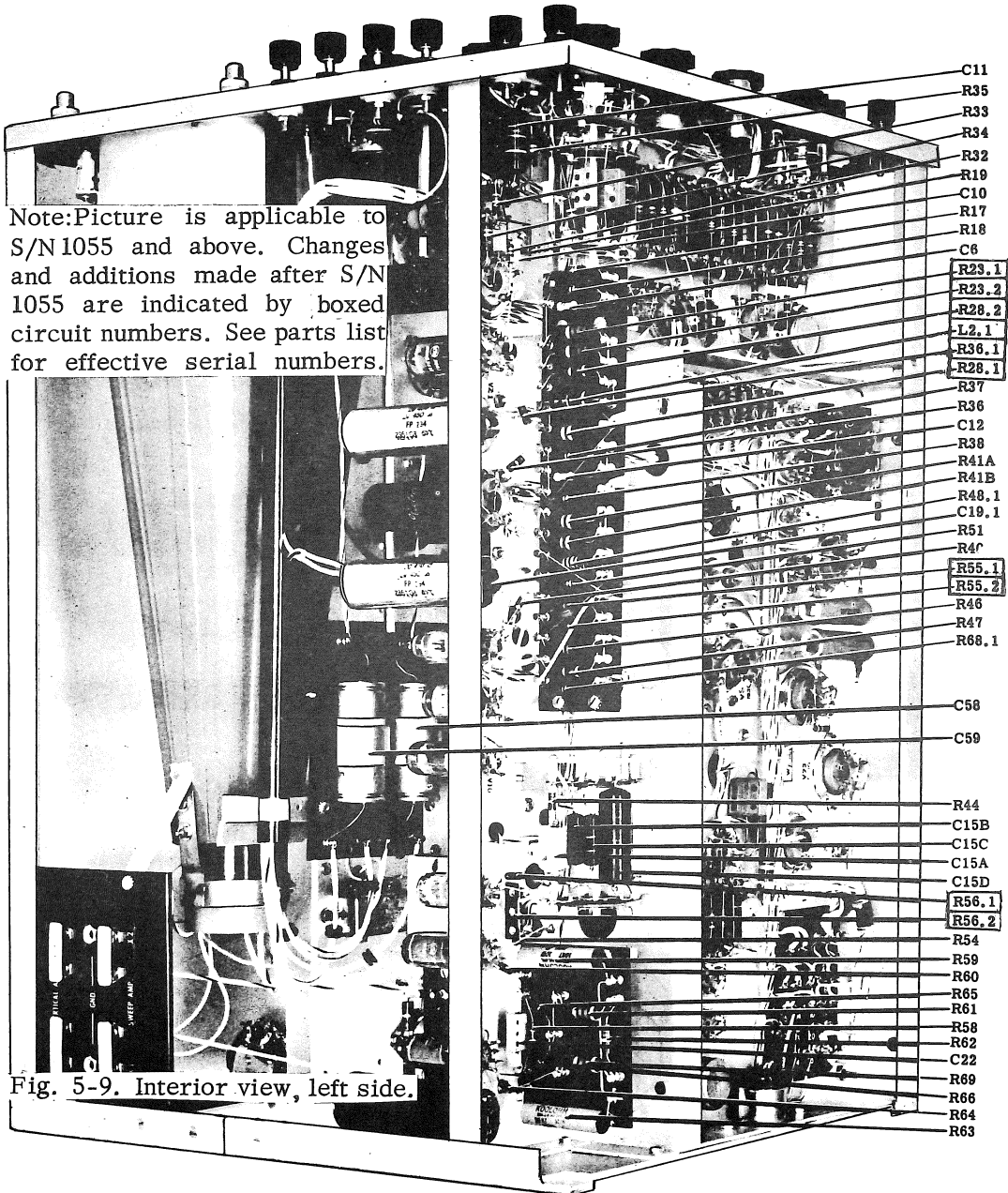

Fig. 5-8. Interior view, left side
(S/N 845-1054)

Note: Picture is applicable to S/N 1055 and above. Changes and additions made after S/N 1055 are indicated by boxed circuit numbers. See parts list for effective serial numbers.



- C11
- R35
- R33
- R34
- R32
- R19
- C10
- R17
- R18
- C6
- R23.1**
- R23.2**
- R28.2**
- L2.1**
- R36.1**
- R28.1**
- R37
- R36
- C12
- R38
- R41A
- R41B
- R48.1
- C19.1
- R51
- R4C
- R55.1**
- R55.2**
- R46
- R47
- R68.1
- C58
- C59
- R44
- C15B
- C15C
- C15A
- C15D
- R56.1**
- R56.2**
- R54
- R59
- R60
- R65
- R61
- R58
- R62
- C22
- R69
- R66
- R64
- R63

Fig. 5-9. Interior view, left side.

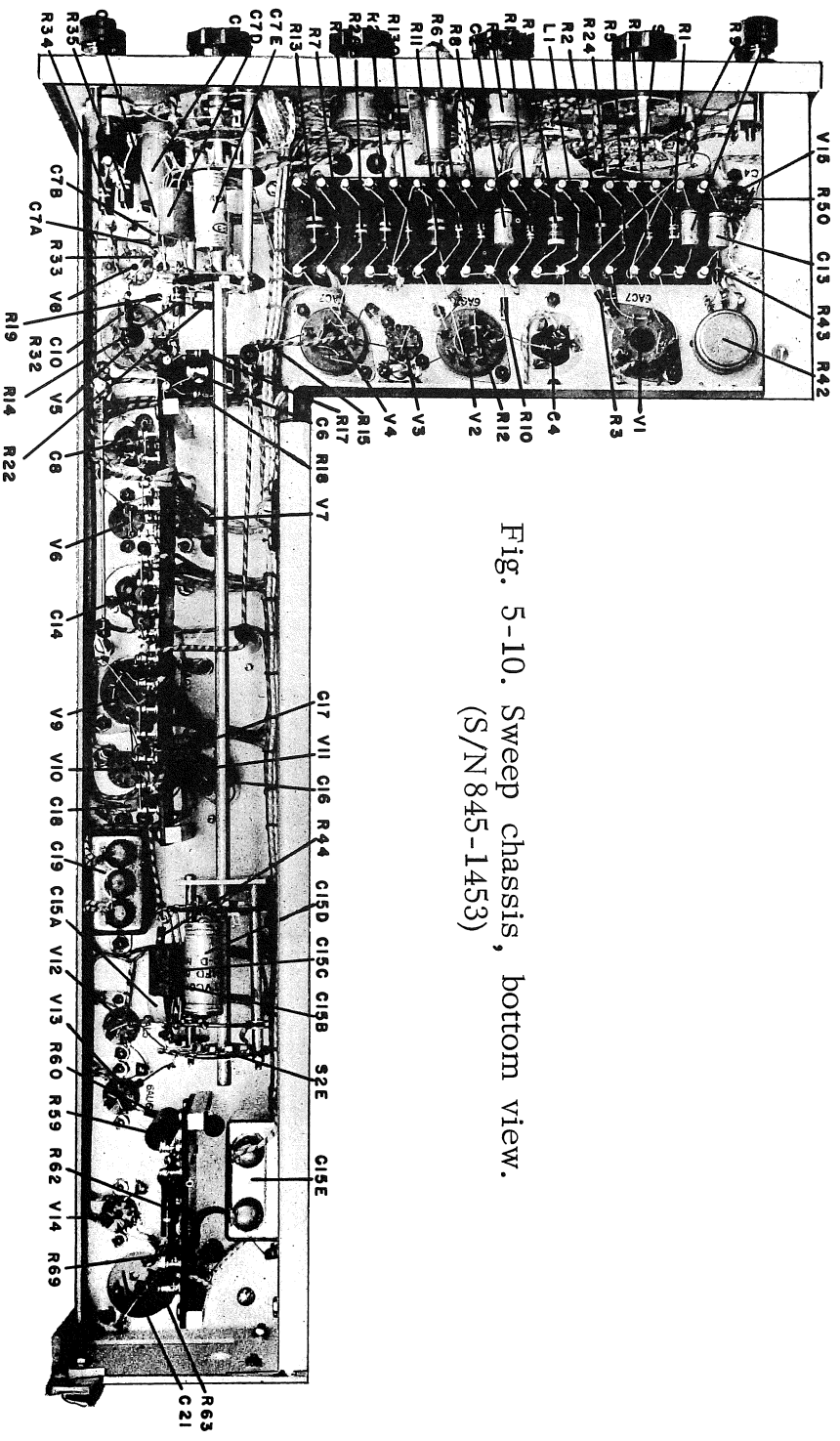

Fig. 5-10. Sweep chassis, bottom view.
(S/N 845-1453)

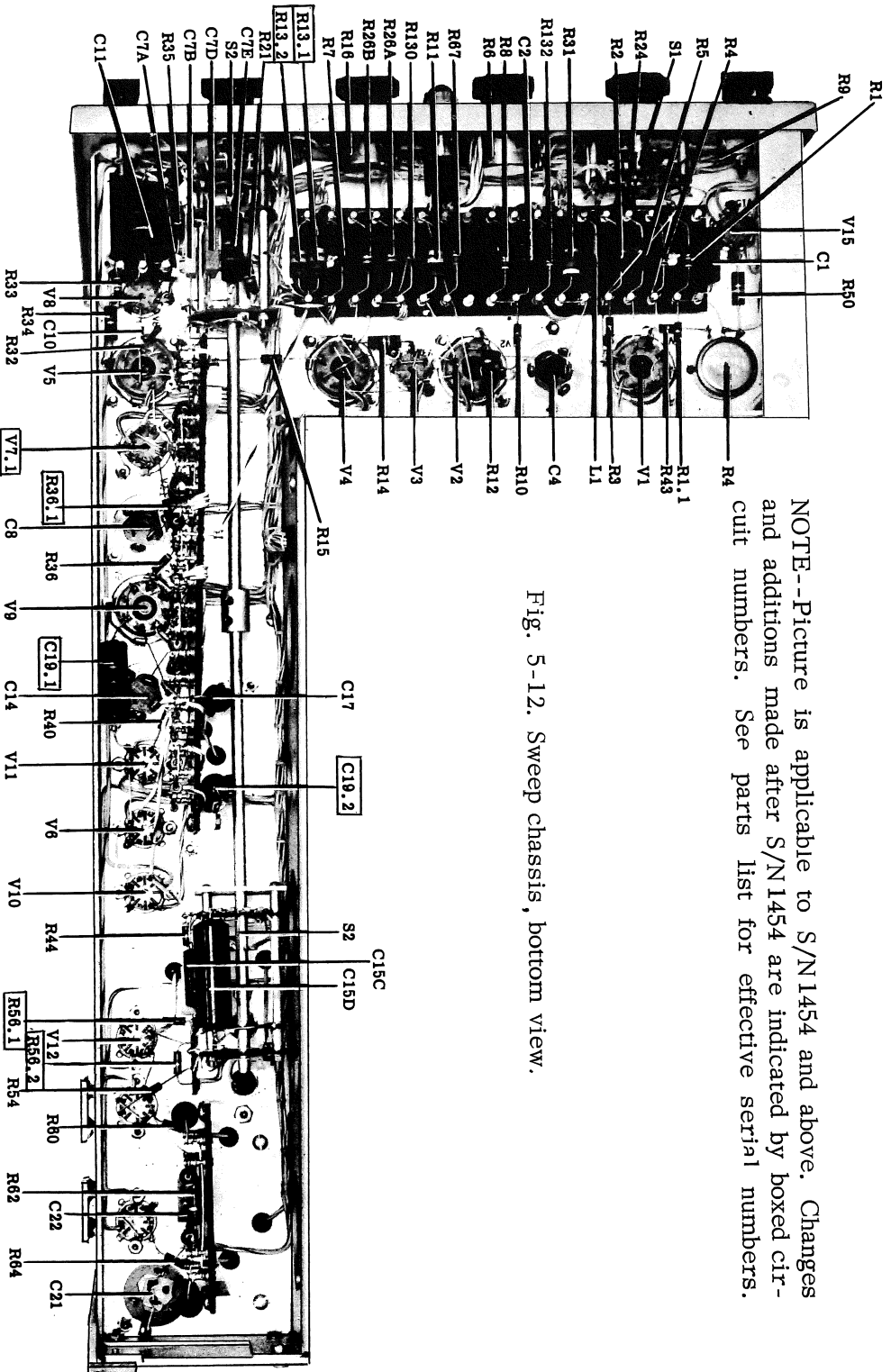

Fig. 5-12. Sweep chassis, bottom view.

NOTE--Picture is applicable to S/N1454 and above. Changes and additions made after S/N 1454 are indicated by boxed circuit numbers. See parts list for effective serial numbers.

NOTE--Picture is applicable to S/N-1454 and above. Changes and additions made after S/N1454 are indicated by boxed circuit numbers. See parts list for effective serial numbers.

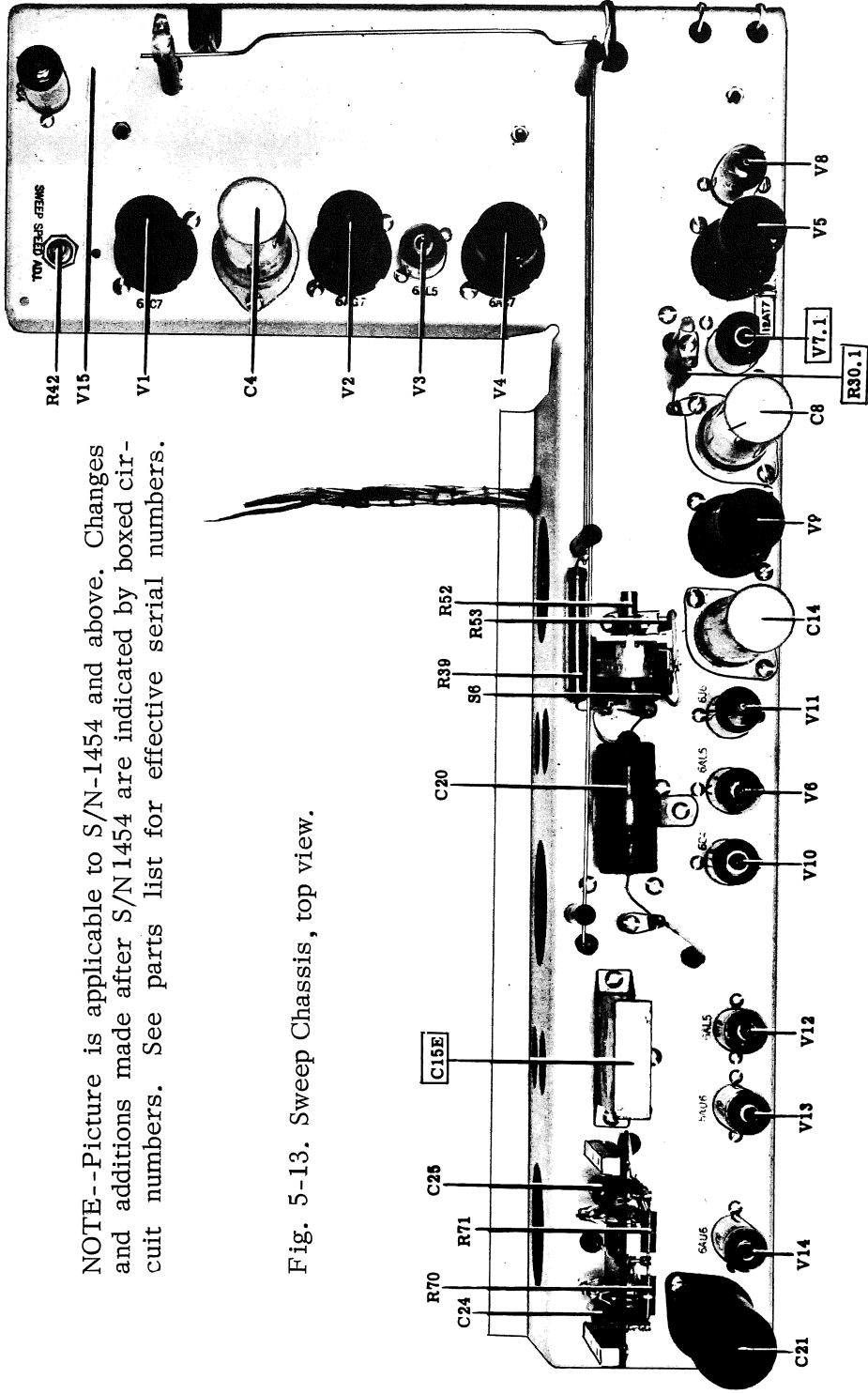

Fig. 5-13. Sweep Chassis, top view.

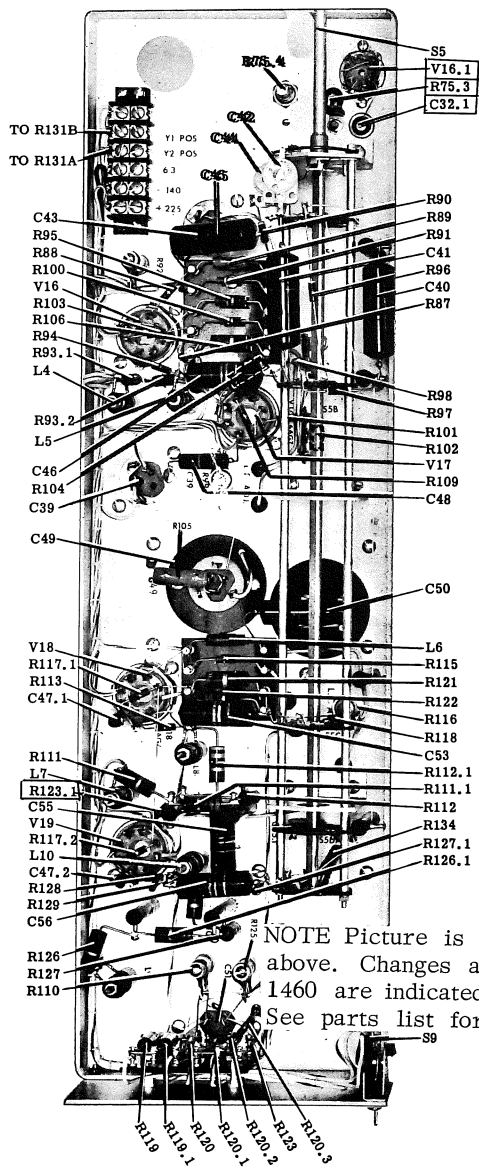

Fig. 5-16. Video Amplifier, top.

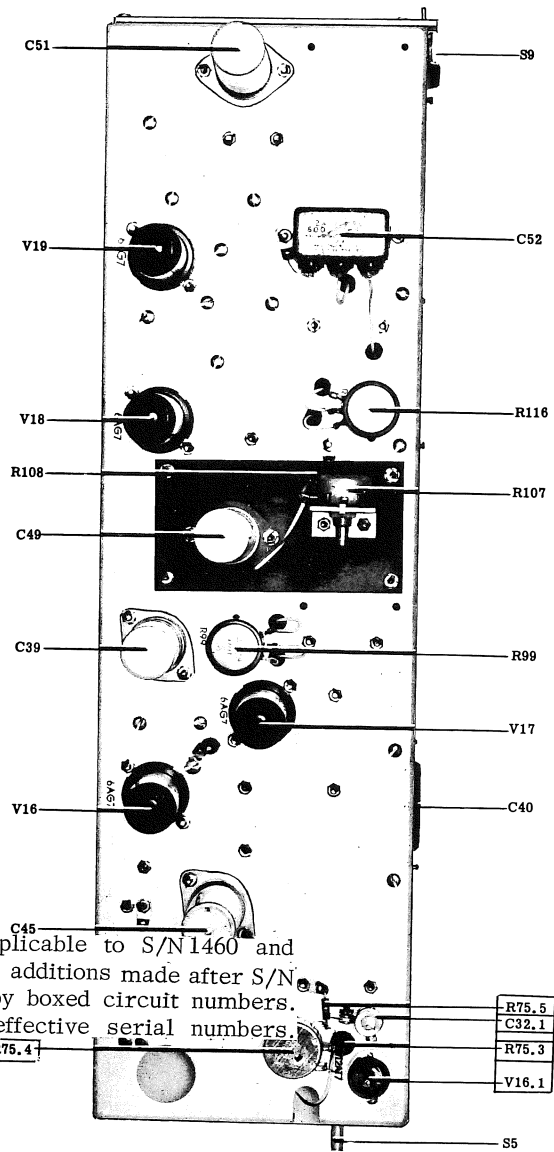

Fig. 5-17. Video Amplifier, bottom.

NOTE Picture is applicable to S/N1460 and above. Changes and additions made after S/N 1460 are indicated by boxed circuit numbers. See parts list for effective serial numbers.

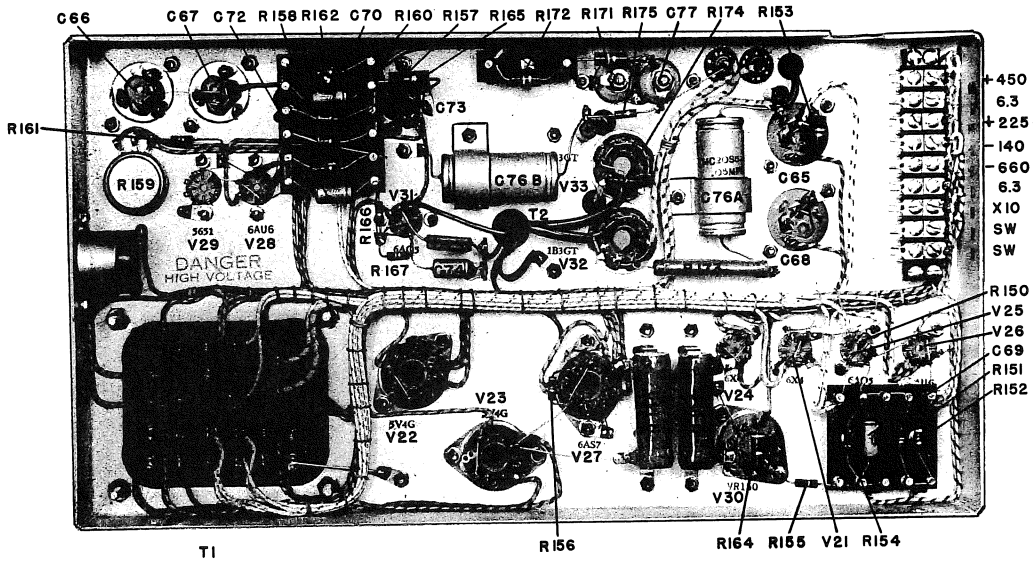

Fig. 5-18. Power Supply, bottom view
(S/N 845-1629)

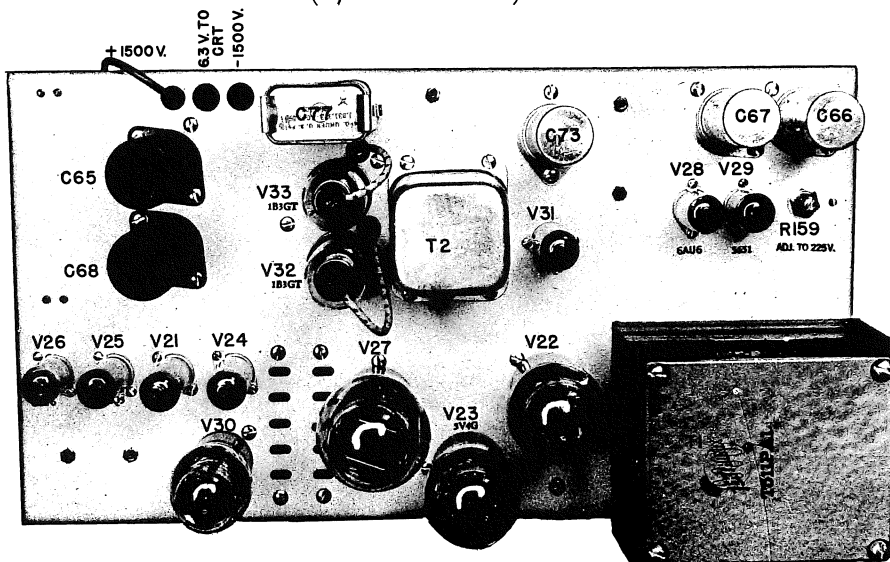

Fig. 5-19. Power Supply, top view.
(S/N 845-1629)

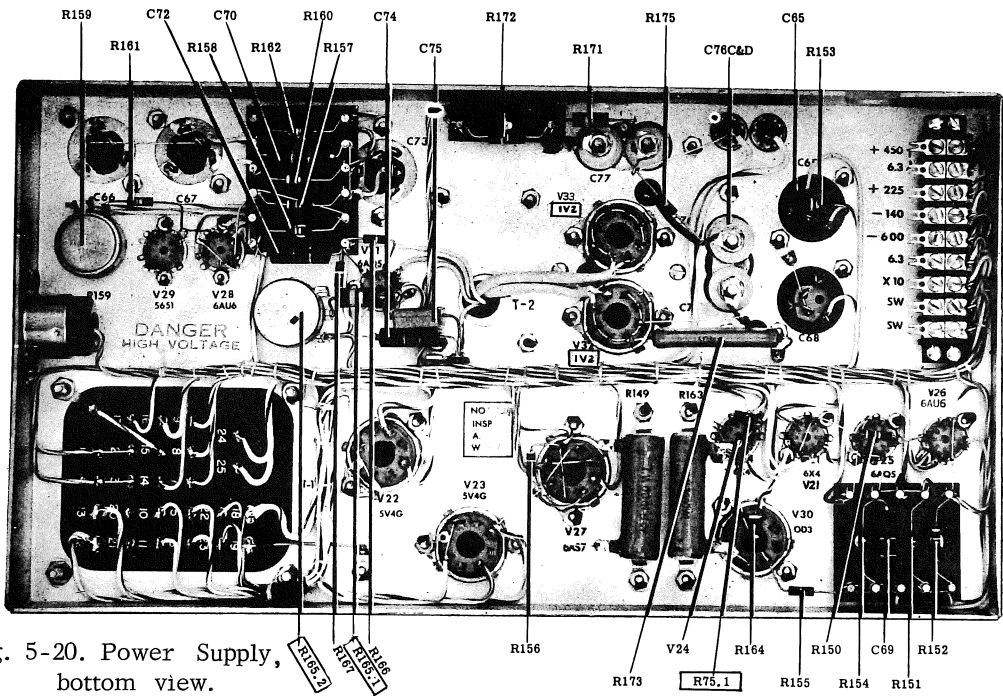

Fig. 5-20. Power Supply, bottom view.

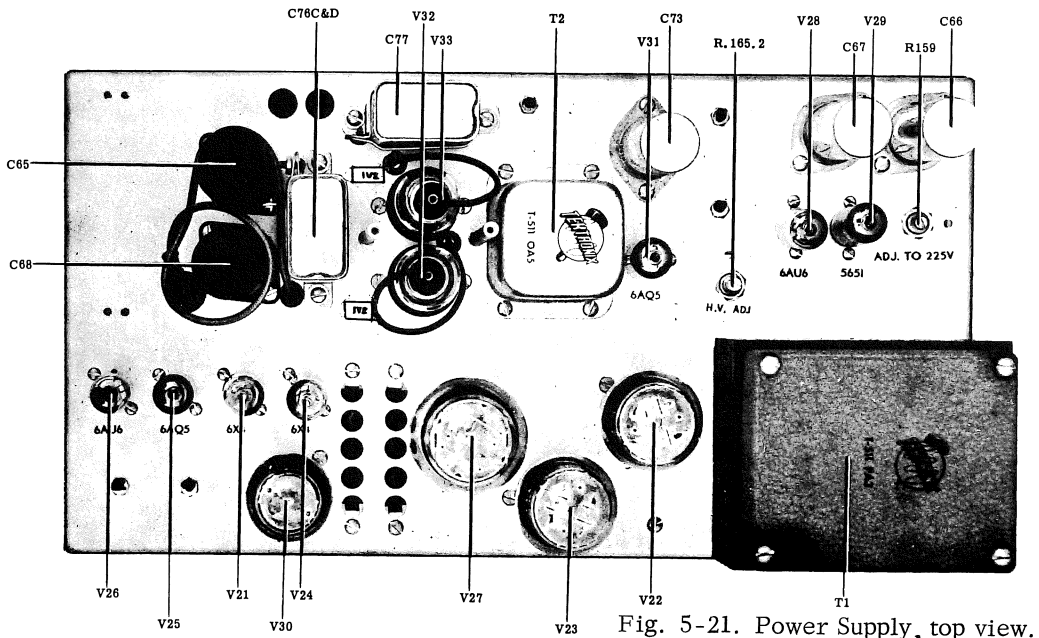

Fig. 5-21. Power Supply, top view.

NOTE--Picture is applicable to S/N1630 and above. Changes and additions made after S/N1630 are indicated by boxed circuit numbers. See parts list for effective serial numbers.

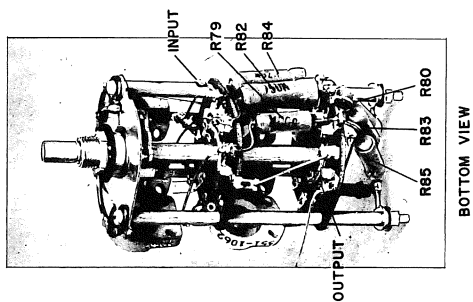
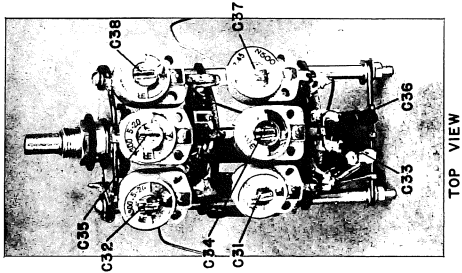

Fig. 5-22. Vertical Attenuator, top. Fig. 5-23. Vertical Attenuator, bottom.
(S/N 845 and up)

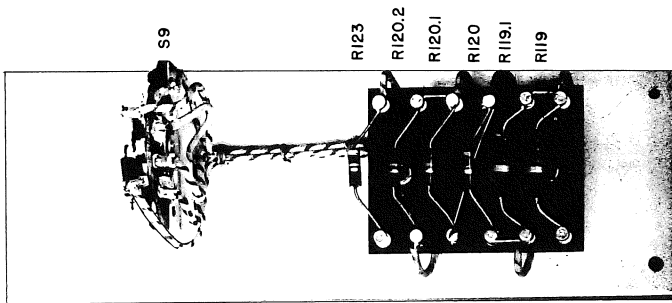

Fig. 5-24. Deflection Polarity Switch and Terminal Board.
(S/N 845 and up)

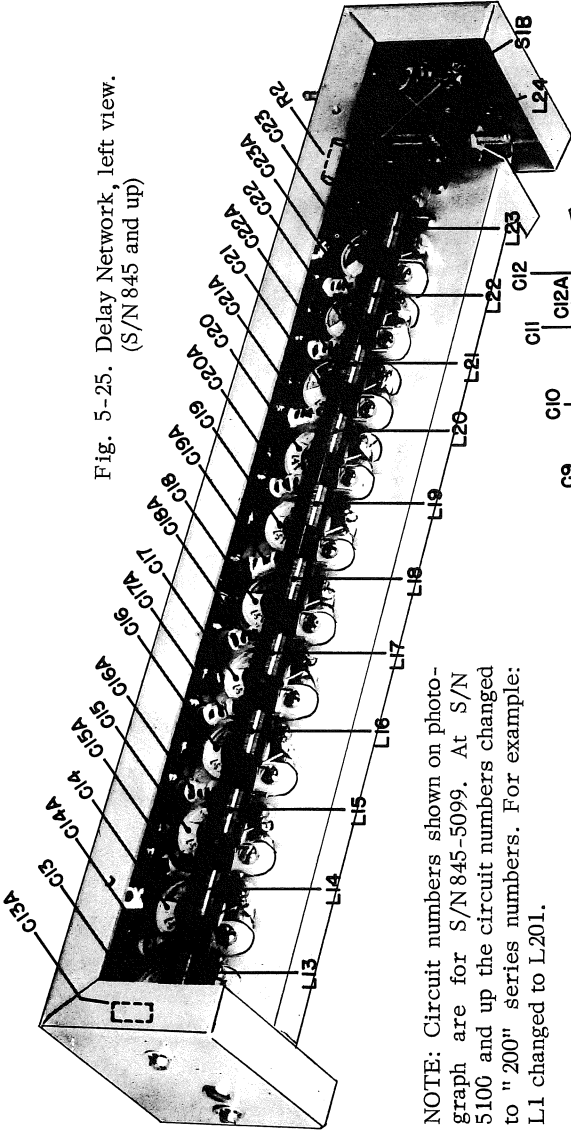

Fig. 5-25. Delay Network, left view.
(S/N 845 and up)

NOTE: Circuit numbers shown on photograph are for S/N 845-5099. At S/N 5100 and up the circuit numbers changed to "200" series numbers. For example: L1 changed to L201.

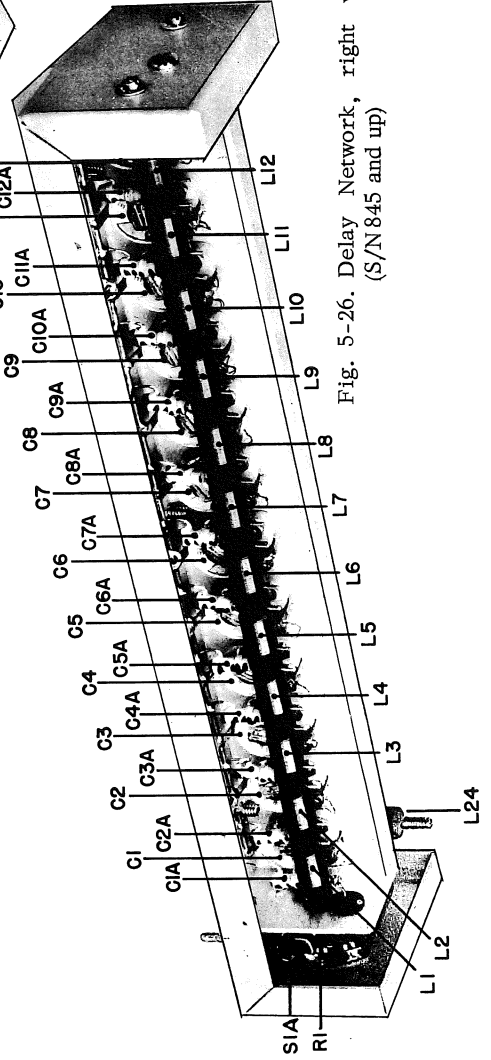

Fig. 5-26. Delay Network, right view.
(S/N 845 and up)

511A OR 511AD AVERAGE PHASE SHIFT CHARACTERISTICS DELAY LINE SWITCHED OUT

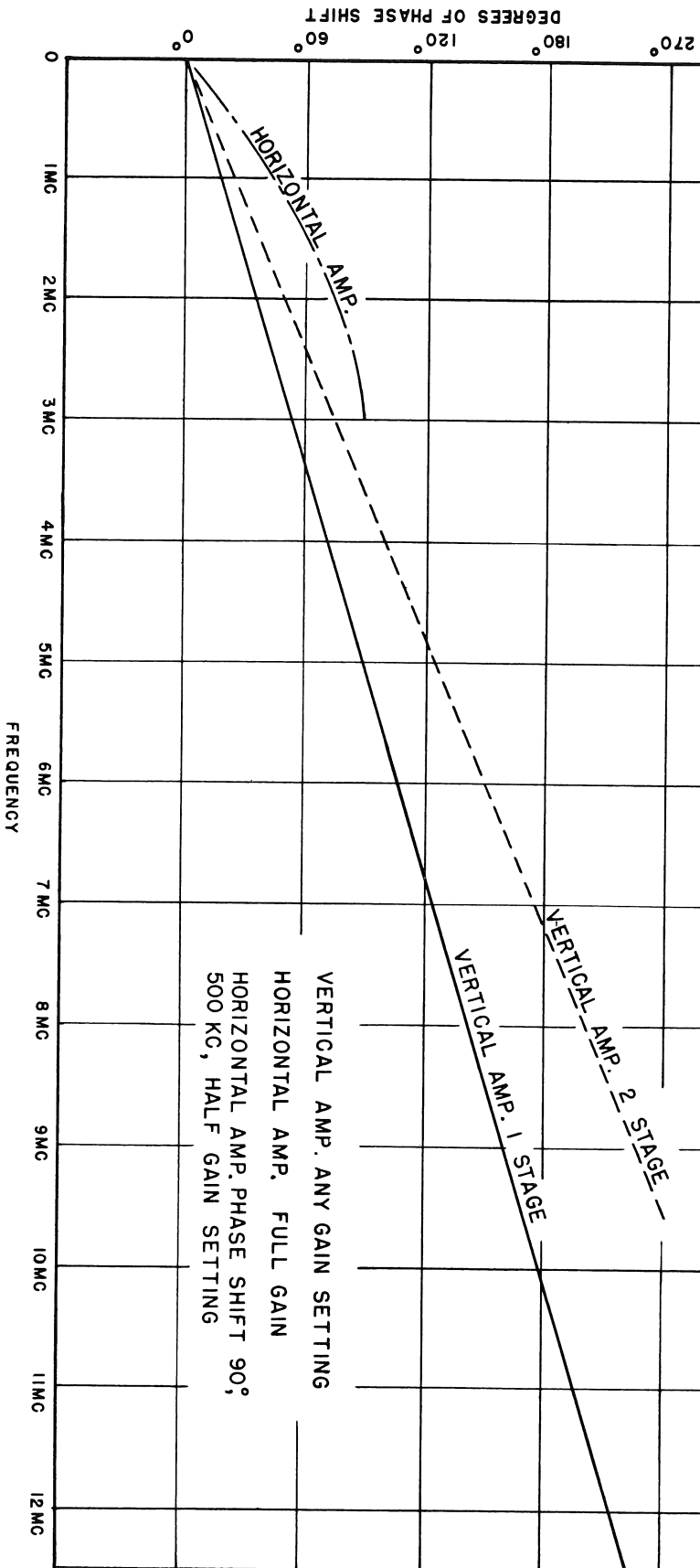

Fig. 5-27

SN 845 and up

TEKTRONIX, INC.

12-28-50

SECTION 6

PARTS LIST

COMPONENT SUBSTITUTION

Due to procurement difficulties, some of the components in any particular instrument may vary slightly from the values shown in this manual. In some cases two or more parts were substituted for one. These substitutions were made to allow earlier shipment when the instrument was constructed. They do not affect the performance of the instrument. In case replacement is necessary, either these values or the ones shown in the manual may be used.

Circuit numbers marked with a double asterisk (***) refer to parts that are not listed by Tektronix part number. These parts may be replaced by purchasing replacements locally, matching physical dimensions and electrical characteristics.

ABBREVIATIONS

Cer.	Ceramic	m	milli or 10^{-3}
Comp.	Composition	Ω	ohm
EMC	Electrolytic, metal cased	PBT	Paper, "Bathtub"
f	Farad	PMC	Paper, metal cased
GMV	Guaranteed minimum value	Poly.	Polystyrene
h	Henry	Prec.	Precision
k	Kilohm or 10^3 ohms	PT	Paper Tubular
M/cer.	Mica or Ceramic	v	Working volts DC
meg	Megohm or 10^6 ohms	Var.	Variable
μ	Micro. or 10^{-6}	w	Watt
$\mu\mu$	Micromicro or 10^{-12}	WW	Wire-wound

SPECIAL NOTES and SYMBOLS

X000	Part first added after this serial number
000X	Part removed at this serial number
(Mod. w/)	Simple replacement not recommended. Modify to value for later instruments and change other listed parts to match.



CAPACITORS

C1	101 and up	.01 μf	Fixed	MT	+ or -20%	400 v	285-510
C2	101-454	.05 μf	Fixed	PTM	10%	600 v	Use 285-520
	455 and up	.01 μf	Fixed	MT	20%	400 v	285-510
C3	101-454X	.1 μf	Fixed	EMT	50%	25 v and clamp	Use 285-526 343-006
C4A, B	101 and up	2x20 μf	Fixed	EMC	-20+ 50%	450 v	290-037
C6	101-844	50 $\mu \mu f$	Fixed	Mica	10%	400 v	Use 281-518
	845 and up	47 $\mu \mu f$	Fixed	Mica or Cer.	20%	400 v	281-518
C7A	101-1682	25 $\mu \mu f$	Fixed	Mica or Cer.	Selected*	500 v	295-002
	1683 and up	22 $\mu \mu f$	Fixed	Mica or Cer.	-0+ 10%	500 v	
C7B	101-454	200 $\mu \mu f$	Fixed	Mica	Selected*	400 v	295-009
	455-1682	250 $\mu \mu f$	Fixed	Mica	Selected*	400 v	
	1683 and up	220 $\mu \mu f$	Fixed	Mica	-5+ 20%	400 v	
C7C	101-864X	2500 $\mu \mu f$	Fixed	Mica	Selected*	400 v	
C7D	101-1682	2500 $\mu \mu f$	Fixed	Mica	Selected*	400 v	
	1683-3550X	2200 $\mu \mu f$	Fixed	Mica	Selected*	400 v	
C7D.1	X3551 and up	.0015 μf	Fixed	MT	-2+ 20%	400 v	285-504
C7E	101-1682	.025 μf	Fixed	PT	5%*	400 v	
	1683-3550X	.022 μf	Fixed	PT	5%*	400 v	
C7E.1	X3551 and up	.015 μf	Fixed	MT	-2+ 20%	500 v	285-512
C7F	X3551 and up	.15 μf	Fixed	MT	-2+ 20%	400 v	285-532
C8A ,B	101 and up	2x20 μf	Fixed	EMC	-20+ 50%	450 v	290-037
C9	101-454	25 $\mu \mu f$	Fixed	Cer.	10%	400 v	Use 281-512
	455-2868X	50 $\mu \mu f$	Fixed	Cer.	10%	500 v	Use 281-518
C10	101-454	11 $\mu \mu f$	Fixed	Cer.	10%	400 v	Use 281-505
	455 and up	8 $\mu \mu f$	Fixed	Cer.	10%	400 v	Use 281-503
C11	101-844	.05 μf	Fixed	PM	20%	400 v	Use 285-519
	845 and up	.047 μf	Fixed	MT	20%	400 v	285-519
C12	101-844	50 $\mu \mu f$	Fixed	Mica or Cer.	20%	400 v	Use 281-518
	845 and up	47 $\mu \mu f$	Fixed	Mica or Cer.	20%	500 v	281-518

*As determined by calibration.



C13	X455 and up	.01 μ f	Fixed	PTM	20%	600 v	285-511
C14A,B	101 and up	2x20 μ f	Fixed	EMC	-20+50%	450 v	290-037
C15A	101 and up	7-45 μ mf	Var.	Cer.		500 v	281-012
C15AA	101-538	35 μ mf	Fixed	Mica or Cer.	10%	400 v)Mod. w/R44, R59, R62, R63) Use 281-512
	539-844	20 μ mf	Fixed	Mica or Cer.	10%	400 v	
	845-5099	12 μ mf	Fixed	Mica or Cer.	10%	400 v	
	5100 and up	27 μ mf	Fixed	Mica or Cer.	10%	500 v	
C15B	101-5585	920 μ mf	Fixed	Mica	2%	400 v [†]	291-018
	5586 and up	.001 μ f	Fixed	Cer.	-7%	400 v*	
C15C	101-5585	.01 μ f	Fixed	Mica	2%	Selected* [†]	291-002
	5586 and up	.01 μ f	Fixed	Special	-8 1/2 to -7 1/2%*		
C15D	101-5585	.1 μ f	Fixed	PT	2%	Selected* [†]	291-002
	5586 and up	.1 μ f	Fixed	Special	-8 1/2 to -7 1/2%*		
C15E	101-5585	1 μ f	Fixed	PBT	2%	Selected* [†]	291-002
	5586 and up	1 μ f	Fixed	Special	-8 1/2 to -7 1/2%*		
C16	101-1774	100 μ mf	Fixed	Mica	10%	400 v	283-505
	1775-2868X	470 μ mf	Fixed	Cer.	20%	400 v	Use 283-522
C17	X581-1496	.1 μ f	Fixed	MT	10%	600 v	285-528
	1497 and up	.1 μ f	Fixed	MT	10%	400 v	285-526
C18	101-1774	100 μ mf	Fixed	Mica	10%	400 v	283-505
	1775-2868X	470 μ mf	Fixed	Cer.	20%	400 v	Use 283-522
C19A,B	101-454	3x.1 μ f	Fixed	PBT	20%	200 v	Use 285-531
	455-2868X	3x.1 μ f	Fixed	PBT	20%	400 v	285-531
C19.1	X2869 and up	.1 μ f	Fixed	MT	20%	400 v	285-526
C19.2	X2869 and up	.1 μ f	Fixed	MT	20%	400 v	285-526
C20	101-5585	.5 μ f	Fixed	PT	20%	400 v	Use 285-540
	5586 and up	1.0 μ f	Fixed	PTM	20%	400 v	285-540
C21	101-787	16 μ f	Fixed	EMC	-20+50%	450 v**	290-036
	788 and up	40 μ f (2x20)	Fixed	EMC	-20+50%	450 v	

[†]Note: S/N's 101-454, order 295-027 for C15B, C, D, and E. For S/N's 455-5585, order 040-022, installing Tektronix mf'd. timing series after Mod. Kit is installed. For C15B, order 291-018; for C15C, D, and E, order 291-020.

*C15C, D and E are all contained in one unit; Tektronix mf'd. timing capacitors.



C22	101-454	.001 μf	Fixed	Mica	20%	500 v	283-527
	455-844	500 $\mu\mu f$	Fixed	Mica	10%	500 v	Use 283-523
	845-1699	470 $\mu\mu f$	Fixed	Mica	10%	500 v	283-522
	1700-1979	300 $\mu\mu f$	Fixed	Mica	10%	500 v	Use 283-518
	1980-5099	330 $\mu\mu f$	Fixed	Mica	10%	500 v	283-518
	5100 and up	220 $\mu\mu f$	Fixed	Mica	5%	500 v	283-513
C23	101-454X	4 μf	Fixed	PMC	20%	600 v**	
C24	101 and up	.001 μf	Fixed	MT	20%	600 v	285-501
C25	101 and up	.001 μf	Fixed	MT	20%	600 v	285-501
C29	X1460 and up	100 $\mu\mu f$	Fixed	Cer.	GMV	500 v	283-000
C30	101-454	4-30 $\mu\mu f$	Var.	Cer.		500 v	Use 281-010
	455-862	5-20 $\mu\mu f$	Var.	Cer.		500 v	Use 281-010
	863 and up	4.5-25 $\mu\mu f$	Var.	Cer.		500 v	281-010
C31	101-454	4-30 $\mu\mu f$	Var.	Cer.		500 v	Use 281-010
	455 and up	4.5-25 $\mu\mu f$	Var.	Cer.		500 v	281-010
C32	101-454	4-30 $\mu\mu f$	Var.	Cer.		500 v	Use 281-010
	455 and up	4.5-25 $\mu\mu f$	Var.	Cer.		500 v	281-010
C32.1	X2406 and up	6.25 μf	Fixed	EMT	-20+50%	300 v	290-000
C33	101-844	50 $\mu\mu f$	Fixed	Cer.	10%	400 v	Use 281-518
	845 and up	47 $\mu\mu f$	Fixed	Cer.	10%	400 v	281-518
C34	101-454	4-30 $\mu\mu f$	Var.	Cer.		500 v	Use 281-010
	455 and up	5-20 $\mu\mu f$	Var.	Cer.		500 v	281-010
C35	101-454	4-30 $\mu\mu f$	Var.	Cer.		500 v	Use 281-010
	455 and up	4.5-25 $\mu\mu f$	Var.	Cer.		500 v	281-010
C36	101-844	25 $\mu\mu f$	Fixed	Cer.	10%	400 v	Use 281-510
	845 and up	22 $\mu\mu f$	Fixed	Cer.	10%	400 v	281-510
C37	101 and up	7-45 $\mu\mu f$	Var.	Cer.		500 v	281-012
C38	101-454	4-30 $\mu\mu f$	Var.	Cer.		500 v	Use 281-010
	455 and up	5-20 $\mu\mu f$	Var.	Cer.		500 v	281-010
C39	101-454X	16 μf	Fixed	EMC	20%	450 v**	
C39A,B	X455-2868	2x15 μf	Fixed	EMC	-0+50%	450 v	Use 295-022
	2869 and up	2x20 μf	Fixed	EMC	-20+50%	450 v	295-022
C40	101-699	.1 μf	Fixed	MT	20%	400 v	285-526
	700 and up	.1 μf	Fixed	MT	20%	600 v	285-528
C41	101-759	.1 μf	Fixed	MT	20%	400 v	285-526
	760 and up	.1 μf	Fixed	MT	20%	600 v	285-528



C42	101-454	4-30 $\mu\mu f$	Var.	Cer.		500 v	Use 281-010
	455-862	5-20 $\mu\mu f$	Var.	Cer.		500 v	Use 281-010
	863 and up	4.5-25 $\mu\mu f$	Var.	Cer.		500 v	281-010
C43	101-759	.1 μf	Fixed	MT	20%	400 v	281-526
	760 and up	.1 μf	Fixed	MT	20%	600 v	285-528
C44	101 and up	1.5-7 $\mu\mu f$	Var.	Cer.		500 v	281-005
C45,B	101 and up	2x20 μf	Fixed	EMC	-20+50%	450 v	290-037
C46	101-1496	.1 μf	Fixed	MT	20%	600 v	285-528
	1497 and up	.1 μf	Fixed	MT	20%	400 v	285-526
C47	101-454X	40 μf	Fixed	EMC	20%	450 v**	
C47.1	X1460 and up	1000 $\mu\mu f$	Fixed	Cer.	GMV	500 v	283-000
C47.2	X1460 and up	1000 $\mu\mu f$	Fixed	Cer.	GMV	500 v	283-000
C48A,B	101-454X	2x20 μf	Fixed	EMC	-20+50%	450 v	290-037
C48	X455 and up	.01 μf	Fixed	MT	10%	400 v	285-510
C49	101-5099	120 μf	Fixed	EMC	-20+50%	150 v	Use 290-018
	5100 and up	150 μf	Fixed	EMC	-20+50%	150 v	290-018
C50	101-759	.1 μf	Fixed	MT	20%	400 v	285-526
	760-1496	.1 μf	Fixed	MT	20%	600 v	285-528
	1497-3128	.1 μf	Fixed	MT	20%	400 v	285-526
	3129 and up	.22 μf	Fixed	MT	20%	400 v	285-533
C51	101-454	2x15 μf	Fixed	EMC	-0+30%	450 v**	
C51A,B	X455 and up	2x20 μf	Fixed	EMC	10%	450 v	295-023
C52A,B	101-4916X	2x.05 μf	Fixed	PBT	20%	400 v	Use(2) 285-519 and clamps(2) 343-005
C52	X4817 and up	.047 μf	Fixed	MT	20%	400 v	285-519
C53	101-1496	.1 μf	Fixed	MT	20%	600 v	285-528
	1497 and up	.1 μf	Fixed	MT	20%	400 v	285-526
C54	101-454X	40 μf	Fixed	EMC	-20+50%	450 v**	
	X845-2868	1000 $\mu\mu f$	Fixed	Cer.	GMV	400 v	Use 283-000
	2869 and up	1000 $\mu\mu f$	Fixed	Cer.	GMV	500 v	283-000
C55	101-454	.5 μf	Fixed	PBT	20%	400 v	Use 285-562 and clamp 343-008
	455-2416	1 μf	Fixed	PBT	20%	400 v	Use 285-540 and clamp 343-014
	2417 and up	.1 μf	Fixed	PTM	20%	400 v	285-526



C56	101-1496	.1 μ f	Fixed	MT	20%	600 v	285-528
	1497 and up	.1 μ f	Fixed	MT	20%	400 v	285-526
C57	X4817 and up	.047 μ f	Fixed	MT	20%	400 v	285-519
C58	101 and up	.1 μ f	Fixed	PTC	20%	2000 v	285-530
C59	101 and up	.1 μ f	Fixed	PTC	20%	2000 v	285-530
C60	101 and up	1 μ f	Fixed	PTM	20%	400 v	285-540
C65	101-454	4 μ f	Fixed	PMC	20%	600 v**	290-036
	455 and up	2x20 μ f	Fixed	EMC	-20+50%	450 v	
C66	101-454	4 μ f	Fixed	PMC	20%	600 v**	290-037
	455 and up	2x20 μ f	Fixed	EMC	-20+50%	450 v	
C67	101-454	.5 μ f	Fixed	PMC	20%	2000 v	285-539
	455 and up	2x20 μ f	Fixed	EMC	-20+50%	450 v	290-037
C68	101-454	.5 μ f	Fixed	PMC	20%	2000 v	285-539
	455 and up	2x20 μ f	Fixed	EMC	-20+50%	450 v	290-036
C69	101-454	.5 μ f	Fixed	PMC	20%	2000 v	285-539
	455 and up	.01 μ f	Fixed	MT	20%	400 v	285-510
C70	X455 and up	.01 μ f	Fixed	MT	20%	400 v	285-510
C71	101-454X	2x20 μ f	Fixed	EMC	-20+50%	450 v	290-037
C72	101-454	2x20 μ f	Fixed	EMC	-20+50%	450 v	290-037
	455 and up	.01 μ f	Fixed	MT	20%	400 v	285-510
C73A,B	X455 and up	2x20 μ f	Fixed	EMC	-20+50%	450 v	290-037
C74	X455-844	.01 μ f	Fixed	PTM	20%	600 v	Use 285-510
	845 and up	.01 μ f	Fixed	MT	20%	400 v	285-510
C75	101-454	.01 μ f	Fixed	MT	20%	400 v	285-510
	455-844	.006 μ f	Fixed	Mica	10%	500 v	Use 283-532
	845 and up	.0068 μ f	Fixed	Mica	10%	500 v	283-532
C76	101-454X	.01 μ f	Fixed	MT	20%	400 v	285-510
C76A,B	X455-1629X	2x.05 μ f	Fixed	PT	20%	2000 v	Use 285-523
C76C,D	X1630 and up	2x.05 μ f	Fixed	PMC	20%	2000 v	285-523
C77	X455 and up	.5 μ f	Fixed	PMC	20%	2000 v	285-539
C107	X5100 and up	.01 μ f	Fixed	MT	20%	400 v	285-510



FUSES

F1	101-5341 5342 and up	4AG 3AG	3 amp. Slo-Blo 3 amp. Slo -Blo	159-007 159-005
----	-------------------------	------------	-----------------------------------	--------------------

INDUCTORS

L1	101-454 455-844 845-4410X	35 μ h 35 μ h 30 μ h	Fixed Fixed Fixed	5% 10% 10%	Use 108-020 Mod. with R1.1, R2.1, R5.1
L1.1	X4411 and up	7 μ h	Fixed	10%	108-020
L2	101-454 455-844 845-2868X	300 μ h 300 μ h 280 μ h	Fixed Fixed Fixed	5% 10% 10%	Use 108-015 Use 108-015 108-015
L2.1	X2869-5099 5100 and up	98 μ h 88 μ h	Fixed Fixed	10% 10%	Use 108-022 108-022
L3	101-454X	8 h at 40 ma. Fixed**			
L4	101-1457 1458-5099 5100 and up	7-12 μ h 5-10 μ h 4.8-8.5 μ h	Var. Var. Var.		Use 114-023 Use 114-020 114-020
L5	101-844 845-5099 5100 - up	14-25 μ h 10-20 μ h 11-19 μ h	Var. Var. Var.		Use 114-004 Use 114-001 114-001
L6	101-454 455-844 845 and up	2.4 μ h 2.0 μ h 1.8 μ h	Fixed Fixed Fixed	5% 5% 5%	108-063 Use 108-010 108-010
L7	101-1457 1458 and up	7-12 μ h 6.5-12 μ h	Var. Var.		Use 114-023 114-023
L8	101-5099 5100 and up	18-32 μ h 17-30 μ h	Var. Var.		Use 114-005 114-004
L9	101-3400 3401 and up	7-12 μ h 4.8-10 μ h	Var. Var.		Use 114-023 Use 114-020
L10	101-1457 1458-5099 5100 and up	18-32 μ h 10-20 μ h 8.5-14 μ h	Var. Var. Var.		Use 114-005 Use 114-001 114-026
L12	101-454X	8h at 135 ma Fixed**			
L13	101-454X	8h at 135 ma Fixed**			



RESISTORS

R1	101 and up	470 k	1/2 w	Fixed	Comp.	10%	302-474
R1.1	X1454 and up	47 Ω	1/2 w	Fixed	Comp.	10%	302-470
R2	101-4410X	1.5 k	1 w	Fixed	Comp.	10%	304-152
R2.1	X4411 and up	560 Ω	1/2 w	Fixed	Comp.	10%	302-561
R3	101 and up	47 Ω	1/2 w	Fixed	Comp.	10%	302-470
R4	101-454	180 Ω	1/2 w	Fixed	Comp.	10%	302-181
	455 and up	330 Ω	1/2 w	Fixed	Comp.	10%	302-331
R5	101-4410X	1.5 k	1 w	Fixed	Comp.	10%	304-152
R5.1	X4411 and up	120 Ω	1/2 w	Fixed	Comp.	10%	302-121
R6	101-5099	500 k		Var.	Comp.	20%	Use 311-035 311-035
	5100 and up	500 k	2 w	Var.	Comp.	20%	
R7	101-454	1 meg	1/2 w	Fixed	Comp.	10%	302-105
	455 and up	1.5 meg	1/2 w	Fixed	Comp.	10%	302-155
R8	101 and up	470 k	1/2 w	Fixed	Comp.	10%	302-474
R9	101 and up	1 meg	1/2 w	Fixed	Comp.	10%	302-105
R10	101 and up	47 Ω	1/2 w	Fixed	Comp.	10%	302-470
R11	101 and up	10 k	2 w	Fixed	Comp.	10%	306-103
R12	101 and up	1 k	1 w	Fixed	Comp.	10%	304-102
R13	101-2945X	10 k	2 w	Fixed	Comp.	10%	306-103
R13.1	X2946 and up	4.7 k	2 w	Fixed	Comp.	10%	306-472
R13.2	X2946 and up	4.7 k	2 w	Fixed	Comp.	10%	306-472
R14	101-454	10 k	1 w	Fixed	Comp.	10%	304-103
	455 and up	15 k	1 w	Fixed	Comp.	10%	304-153
R15	101 and up	47 Ω	1/2 w	Fixed	Comp.	10%	302-470
R16	101-454	500 k	2 w	Var.	Comp.	20%	311-034
	455-5099	100 k	2 w	Var.	Comp.	20%	Use 311-026 311-026
	5100 and up	100 k	2 w	Var.	Comp.	20%	
R17	101 and up	100 k	1/2 w	Fixed	Comp.	10%	302-104



R18	101 and up	220 k	1/2 w	Fixed	Comp.	10%	302-224
R19	101 and up	47 Ω	1/2 w	Fixed	Comp.	10%	302-470
R20	101-454	2x2 meg	2 w	Var.	Comp.	10%) Use Mod. Kit 040-016
R20A	X455-1405X	2 meg	2 w	Var.	Comp.	-10+ 20%	
R20B	X455-1405X	2 meg	2 w	Var.	Comp.	-0+ 20%	
R20C,D	X1406 and up	2x220 k	2 w	Var.	Comp.	20%	312-100
R20C1-9	X1406 and up	220 k	1/2 w	Fixed	Comp.	10%	302-224
R20D1-9	X1406 and up	200 k	1/2 w	Fixed	Prec.	1%	309-051
R21	101-1682	100 k	1/2 w	Fixed	Comp.	5%	301-104
	1683 and up	220 k	1 w	Fixed	Comp.	5%	303-224
R22	101-1682X	100 k	1/2 w	Fixed	Comp.	5%	301-104
R23	101-2945X	4.7 k	2 w	Fixed	Comp.	10%	306-472
R23.1	X2946 and up	2.7 k	2 w	Fixed	Comp.	10%	306-272
R23.2	X2946 and up	2.2 k	2 w	Fixed	Comp.	10%	306-222
R24	101-454X	27 k	1 w	Fixed	Comp.	10%	304-273
	X720 and up	22 meg	1/2 w	Fixed	Comp.	10%	302-226
R25	101-2868X	47 k	1 w	Fixed	Comp.	10%	304-473
R26A	X455 and up	10 k	1 w	Fixed	Comp.	10%	304-103
R26B	X455 and up	10 k	1 w	Fixed	Comp.	10%	304-103
R27	101-454	15 k	1 w	Fixed	Comp.	10%	304-153
	455-844	18 k	1/2 w	Fixed	Comp.	10%	302-183
	845-2868X	18 k	1 w	Fixed	Comp.	10%	304-183
R28	101-454	820 k	1 w	Fixed	Comp.	10%	304-824
	455-2868X	120 k	1/2 w	Fixed	Comp.	10%	302-124
R28.1	X2869-2899X	10 k	2 w	Fixed	Comp.	10%	306-103
	X2950 and up	10 k	2 w	Fixed	Comp.	10%	306-103
R28.12	X2900-2949X	27 k	2 w	Fixed	Comp.	10%	306-273
R28.2	X2869 and up	4.7 k	1 w	Fixed	Comp.	10%	304-472
R29	101-454	1 meg	1/2 w	Fixed	Comp.	10%	302-105
	455-2868X	180 k	1/2 w	Fixed	Comp.	10%	302-184
R30	101-2868X	10 k	1 w	Fixed	Comp.	10%	304-103
R30.1	X2869 and up	47 k	1 w	Fixed	Comp.	10%	304-473



R31	X455 and up	4.7 k	2 w	Fixed	Comp.	10%	306-472
R32	101 and up	470 k	1/2 w	Fixed	Comp.	10%	302-474
R33	101 and up	470 k	1/2 w	Fixed	Comp.	10%	302-474
R34	101 and up	10 k	1 w	Fixed	Comp.	10%	304-103
R35	101 and up	10 k	1 w	Fixed	Comp.	10%	304-103
R36	101 and up	47 Ω	1/2 w	Fixed	Comp.	10%	302-470
R36.1	X2869 and up	47 Ω	1/2 w	Fixed	Comp.	10%	302-470
R37	101-454	100 k	1/2 w	Fixed	Comp.	10%	302-104
	455 and up	120 k	1/2 w	Fixed	Comp.	10%	302-124
R38	101 and up	100 k	1/2 w	Fixed	Comp.	10%	302-104
R39	101-454	200 k	1 w	Fixed	Comp.	5%	Use 310-501
	455-844	200 k	2 w	Fixed	Carbon	5%	Use 310-501
	845-5099	200 k	2 w	Fixed	Carbon	2%	Use 310-501
	5100 and up	200 k	2 w	Fixed	Prec.	2%	310-501
R39.1*	X1406-2600X	33 meg	1/2 w	Fixed	Comp.	10%	Use 302-106 and 302-226
R39.11	X2601 and up	10 meg	1/2 w	Fixed	Comp.	10%	302-106
R39.12	X2601 and up	22 meg	1/2 w	Fixed	Comp.	10%	302-226
R40	X581 and up	470 Ω	1/2 w	Fixed	Comp.	10%	302-471
R41	101-454	10 k	2 w	Fixed	Comp.	10%	306-103
R41A,B	X455 and up	10 k	2 w	Fixed	Comp.	10%	306-103
R42	101-454	20 k	1/4 w	Var.	Comp.	20%	Use 311-018
	455-5099	500 k	1/4 w	Var.	Comp.	20%	Use 311-034
	5100 and up	500 k	2 w	Var.	Comp.	20%	311-034
R43	101-454	33 k	1 w	Fixed	Comp.	10%	304-333
	455-5099	1 meg	1/2 w	Fixed	Comp.	10%	302-105
	5100 and up	820 k	1/2 w	Fixed	Comp.	10%	302-824
R44	101-454	4.7 k	1/2 w	Fixed	Comp.	10%	Mod. w/C15AA, R59,
	455-538	1.5 k	1/2 w	Fixed	Comp.	10%	R62, R63. Use Tek #
	539 and up	4.7 k	1/2 w	Fixed	Comp.	10%	302-472
							302-472
R45	101 and up	10 k	1 w	Fixed	Comp.	10%	304-103
R46	101 and up	10 k	1 w	Fixed	Comp.	10%	304-103
R47	101 and up	4.7 k	1 w	Fixed	Comp.	10%	304-472

*S/N-1968-2025, R39.1 is 22 meg, 1/2 w 302-226. At S/N 2601, it changed to R39.11 and R39.12, connected in series.



R48	101-2868X	10 k	1 w	Fixed	Comp.	10%	304-103
R48.1	X2869 and up	18 k	2 w	Fixed	Comp.	10%	306-183
R49	101-2868X	10 k	1 w	Fixed	Comp.	10%	304-103
R50	101-454	8.2 k	1/2 w	Fixed	Comp.	10%	302-822
	455 and up	270 k	1/2 w	Fixed	Comp.	10%	302-274
R51	101-555	330 k	1/2 w	Fixed	Comp.	10%	302-334
	556 and up	680 k	1/2 w	Fixed	Comp.	10%	302-684
R52	101-5099	100 k	1/4 w	Var.	Comp.	20%	Use 311-027
	5100 and up	100 k	1/2 w	Var.	WW	20%	Use 311-027
R53	101 and up	8.2 k	1/2 w	Fixed	Comp.	10%	302-822
R54	101 and up	180 Ω	1/2 w	Fixed	Comp.	10%	302-181
R55	101-454X	5 k	10 w	Fixed	WW	5%	(2) 308-023*
	X581-2600X***	35 meg	1/2 w	Fixed	Comp.	10%	Use 302-106 and 302-226
R55.1	X2601 and up	10 meg	1/2 w	Fixed	Comp.	10%	302-106
R55.2	X2601 and up	22 meg	1/2 w	Fixed	Comp.	10%	302-226
R56	101-454***	30 meg	1/2 w	Fixed	Comp.	10%	Use 302-106
	455-2600X***	35 meg	1/2 w	Fixed	Comp.	10%	and 302-226
R56.1	X2601 and up	10 meg	1/2 w	Fixed	Comp.	10%	302-106
R56.2	X2601 and up	22 meg	1/2 w	Fixed	Comp.	10%	302-226
R57	101-5099	100 k	1/4 w	Var.	Comp.	10%	Use 311-026
	5100 and up	100 k	2 w	Var.	Comp.	20%	311-026
R58	101 and up	4.7 k	1/2 w	Fixed	Comp.	10%	302-472
R59	101-538	30 k	10 w	Fixed	WW	5%	Mod. w/C15AA, R44,
	539 and up	25 k	10 w	Fixed	WW	5%	Use 308-026 308-026
R60	101 and up	180 Ω	1/2 w	Fixed	Comp.	10%	302-181
R61	101 and up	4.7 k	2 w	Fixed	Comp.	10%	306-472

*NOTE: Use (2) 308-023, 10 w resistors in parallel.

***NOTE: S/N 1968-2025, R55 and R56 are 22 meg, 1/2 w, 302-226. At S/N 2601, R55 changed to R55.1 and R55.2 connected in series; R56 changed to R56.1 and R56.2 connected in series.



R62	101-538	4.7 k	2 w	Fixed	Comp.	10%	Mod. w/C15AA, R44, R59, and R63. Use 304-122
	539 and up	1.2 k	1 w	Fixed	Comp.	10%	304-122
R63	101-538	30 k	10 w	Fixed	WW	5%	Mod. w/C15AA, R44, R59, R62. Use 308-026
	539 and up	25 k	10 w	Fixed	WW	5%	308-026
R64	101 and up	180 Ω	1/2 w	Fixed	Comp.	10%	302-181
R65	101-844	510 Ω	1/2 w	Fixed	Comp.	10%	Use 302-561
	845-5099	560 Ω	1/2 w	Fixed	Comp.	10%	302-561
	5100 and up	1.8 k	1 w	Fixed	Comp.	10%	304-182
R66	101-844	510 Ω	1/2 w	Fixed	Comp.	10%	Use 302-561
	845-5099	560 Ω	1/2 w	Fixed	Comp.	10%	302-561
	5100 and up	1.8 k	1 w	Fixed	Comp.	10%	304-182
R67	101-454	390 k	1/2 w	Fixed	Comp.	10%	302-394
	455 and up	820 k	1/2 w	Fixed	Comp.	10%	302-824
R68	101-454	50 k	1/4 w	Var.	Comp.	20%	Use 311-023
	455-5099	100 k	1/4 w	Var.	Comp.	20%	Use 311-026
	5100 and up	100 k	2 w	Var.	Comp.	20%	311-026
R68.1	X845-1054	470 k	1/2 w	Fixed	Comp.	10%	302-474
	1055 and up	120 k	1/2 w	Fixed	Comp.	10%	302-124
R69	101-454	2.2 k	1 w	Fixed	Comp.	10%	304-222
	455 and up	4.7 k	2 w	Fixed	Comp.	10%	306-472
R70	101 and up	2.2 meg	1 w	Fixed	Comp.	10%	304-225
R71	101 and up	2.2 meg	1 w	Fixed	Comp.	10%	304-225
R72	X455 and up	47 Ω	1/2 w	Fixed	Comp.	10%	302-470
R73	101 and up	50 Ω	2 w	Var.	WW	20%	311-055
R74	101-454	47 Ω	1/2 w	Fixed	Comp.	10%	302-470
	455 2405X	Selected	1/2 w	Fixed	Comp.)		
R75	101-454	Selected	1/2 w	Fixed	Comp.)	Use Mod. Kit	040-015
	455-2405X	Selected	1/2 w	Fixed	Comp.)		
R75.1	X2406 and up	1 meg	1/2 w	Fixed	Comp.	10%	302-105
R75.2	X2406 and up	10 meg	1/2 w	Fixed	Comp.	10%	302-106
R75.3	X2406 and up	39 k	1/2 w	Fixed	Comp.	10%	302-393
R75.4	X2406-5099	10 k	1/4 w	Var.	WW	20%	Use 311-015
	5100 and up	10 k	2 w	Var.	WW	20%	311-015



R75.5	X2406 and up	27 k	1/2 w	Fixed	Comp.	10%	302-273
R76	101-2405X	5 k	1 w	Var.	WW	10%	Use Mod. Kit 040-015
R76.1	X2406-5099	20 k	1/2 w	Var.	WW	5%	Use 312-003
	5100 and up	20 k	3 w	Var.	WW	2%	312-003
R76.2	X2406 and up	13.23 k	1/2 w	Fixed	Prec.	1%	309-035
R76.3	X2406 and up	5.25 k	1/2 w	Fixed	Prec.	1%	309-032
R76.4	X2406 and up	1.582 k	1/2 w	Fixed	Prec.	1%	309-029
R76.5	X2406 and up	416 Ω	1/2 w	Fixed	Prec.	1%	309-079
R76.6	X2406 and up	142 Ω	1/2 w	Fixed	Prec.	1%	309-071
R76.7	X2406 and up	60 Ω	1/2 w	Fixed	Prec.	1%	309-067
R77	101-454	4 meg	2 w	Fixed	Prec.	1%**	
	455 and up	9 meg	1 w	Fixed	Prec.	1%	310-106
R79	101 and up	875 k	1 w	Fixed	Prec.	1%	310-096
R80	101-844	142.9 k	1/2 w	Fixed	Prec.	1%	Use 309-092
	845 and up	143 k	1/2 w	Fixed	Prec.	1%	309-092
R82	101 and up	750 k	1 w	Fixed	Prec.	1%	310-095
R83	101 and up	333 k	1/2 w	Fixed	Prec.	1%	309-053
R84	101 and up	500 k	1/2 w	Fixed	Prec.	1%	309-003
R85	101 and up	1 meg	1/2 w	Fixed	Prec.	1%	309-014
R87	X920-1459	4.7 k	1/2 w	Fixed	Comp.	10%	302-472
	1460 and up	10 k	1/2 w	Fixed	Comp.	10%	302-103
R88	101 and up	47 Ω	1/2 w	Fixed	Comp.	10%	302-470
R89	101 and up	1 meg	1/2 w	Fixed	Prec.	1%	309-014
R90	101 and up	4.7 k	1/2 w	Fixed	Comp.	10%	302-472
R91	101 and up	220 k	1/2 w	Fixed	Comp.	10%	302-224
R92	101-454	4.7 k	2 w	Fixed	Comp.	10%	306-472
	455 and up	2 k	5 w	Fixed	WW	5%	308-003
R93	101-454	1.2 k	1 w	Fixed	Comp.	5%	Use 305-122
	455-844X	1.2 k	2 w	Fixed	Comp.	5%	305-122



R93.1	X845-2867 2868 and up	680 Ω 560 Ω	1 w 1 w	Fixed Fixed	Comp. Comp.	Selected Selected*	Use 312-534 312-534
R93.2	X845-2867 2868 and up	560 Ω 560 Ω	1 w 1 w	Fixed Fixed	Comp. Comp.	Selected Selected**	Use 312-534 312-534
R94	101 and up	47 Ω	1/2 w	Fixed	Comp.	10%	302-470
R95	101-454 455-844 845 and up	27 k 10 k 10 k	1 w 2 w 1 w	Fixed Fixed Fixed	Comp. Comp. Comp.	10% 10% 10%	304-273 306-103 304-103
R96	101-454 455 and up	9 meg 9.1 meg	1/2 w 1/2 w	Fixed Fixed	Comp. Comp.	5% 5%	Use 309-232 301-915
R97	101-454 455 and up	9 meg 9.1 meg	1/2 w 1/2 w	Fixed Fixed	Comp. Comp.	5% 5%	Use 309-232 301-915
R98	101 and up	220 k	1/2 w	Fixed	Comp.	10%	302-224
R99	101-5099 5100 and up	500 k 500 k	1/4 w 2 w	Var. Var.	Comp. Comp.	20% 20%	Use 311-034 311-034
R100 [†]	101 and up	220 k	1/2 w	Fixed	Comp.	10%	312-517
R101	101 and up	100 Ω	1/2 w	Fixed	Comp.	10%	302-101
R102	101 and up	1 meg	1/2 w	Fixed	Prec.	1%	309-014
R103	101-454 *455 and up	47 k 68 k	1/2 w 1/2 w	Fixed Fixed	Comp. Comp.	10% 10%	302-473 312-517
R104	101 and up	680 Ω	2 w	Fixed	Comp.	10%	306-681
R105	101-454 455 and up	680 Ω 2 k	2 w 5 w	Fixed Fixed	Comp. WW	10% 5%	306-681 308-003
R106	101-454 455-2370 2371 and up	680 Ω 820 Ω 680 Ω	2 w 2 w 2 w	Fixed Fixed Fixed	Comp. Comp. Comp.	10% 10% 10%	306-681 306-821 306-681
R107	101-4487	500 Ω	1/4 w	Var.	Comp.	Selected	Use 312-002
				Also change R108 to 270 Ω)			
	4488 and up	500 Ω	2 w	Var.	Comp.	Selected**)	312-002
R107A	X4488 and up	Selected***	1/2 w	Fixed	Comp.)	
R107.1	X5100 and up	10 Ω	1/2 w	Fixed	Comp.	10%	302-100
R108	101-4487 4488 and up	150 Ω 270 Ω	1/2 w 1/2 w	Fixed Fixed	Comp. Comp.	10% 5%	302-151 301-271

*R93.1 and R93.2 selected to total 1130 Ω, +or-3%, S/N 2868 and up. Furnished as a unit.

†R100 and R103 paired, both either 0 to +10% tolerance or 0 to -10% tolerance. Furnished as a unit.

***R107A selected to shunt R107 so that resistance totals 400 Ω, +or-3%.



R109	101-454X X1460 and up	100 k 1 meg	2 w 1/2 w	Fixed Fixed	Comp. Comp.	10% 10%	306-104 302-105
R110	101-454 455 and up	2 k 1.5 k	10 w 5 w	Fixed Fixed	WW WW	5% 5%	Use 308-055 308-002
R111	101-844 845 and up	680 Ω 330 Ω	2 w 2 w	Fixed Fixed	Comp. Comp.	Selected* Selected*	
R111.1	X845 and up	330 Ω	2 w	Fixed	Comp.	Selected*	
R112	101-844 845 and up	680 Ω 330 Ω	2 w 2 w	Fixed Fixed	Comp. Comp.	Selected* Selected*	
R112.1	X845 and up	330 Ω	2 w	Fixed	Comp.	Selected*	
R113	101 and up	47 Ω	1/2 w	Fixed	Comp.	10%	302-470
R114	X455-854 855-5099 5100 and up	33 k 22 k 10 k	1/2 w 1/2 w 1/2 w	Fixed Fixed Fixed	Comp. Comp. Comp.	10% 10% 10%	302-333 302-223 302-103
R115	101-454 455 and up	100 k 220 k	1/2 w 1/2 w	Fixed Fixed	Comp. Comp.	10% 10%	302-104 302-224
R115.1	X3409 and up	82 Ω	1/2 w	Fixed	Comp.	10%	302-820
R116	101-5099 5100 and up	1 meg 1 meg	1/4 w 2 w	Var. Var.	Comp. Comp.	20% 20%	Use 311-039 311-039
R117	101-454 455-844X	100 k 68 k	1/2 w 1/2 w	Fixed Fixed	Comp. Comp.	10% 10%	302-104 302-683
R117.1	X1460 and up	1 meg	1/2 w	Fixed	Comp.	10%	302-105
R117.2	X1460 and up	1 meg	1/2 w	Fixed	Comp.	10%	302-105
R118	101 and up	1 meg	1/2 w	Fixed	Comp.	10%	302-105
R119	X455 and up	2.2 k	2 w	Fixed	Comp.	10%	306-222
R119.1	X845 and up	2.2 k	2 w	Fixed	Comp.	10%	306-222
R120	101-454 455-2868 2869-5099X	68 Ω 470 k 470 k	1 w 1/2 w 1/2 w	Fixed Fixed Fixed	Comp. Comp. Comp.	10% 10% -6%-10%	304-680 Use 312-521 312-521
R120.1	X845-2868 2869-5099X	10 k 10 k	1/2 w 1/2 w	Fixed Fixed	Comp. Comp.	10% -5%+10%	Use 312-511 312-511
R120.2	X845-2868 2869-5099X	10 k 10 k	1/2 w 1/2 w	Fixed Fixed	Comp. Comp.	10% -5%+10%	Use 312-511 312-511

*Selected in groups of four with total series resistance 1150 Ω , +or-2%. Furnished as a unit with R126, R127. Total 8 resistors, part number 312-546.



R120.3	X845-2868 2869-5099X	56 k 56 k	1/2 w 1/2 w	Fixed Fixed	Comp. Comp.	10% +6%+10%	Use 312-514 312-514
R121*	101-454 455 and up	220 Ω 220 Ω	2 w 2 w	Fixed Fixed	Comp. Comp.	10% Selected*	Use 312-544 312-544
R122*	101-454 455 and up	220 Ω 220 Ω	2 w 2 w	Fixed Fixed	Comp. Comp.	10% Selected*	Use 312-544 312-544
R123	101-454 455-2868 2869 and up	1 meg 470 k 470 k	1/2 w 1/2 w 1/2 w	Fixed Fixed Fixed	Comp. Comp. Comp.	10% 10% +6%+10%	302-105 Use 312-520 312-520
R123.1	X1613 and up	100 Ω	1/2 w	Fixed	Comp.	10%	302-101
R125	101-454 455 and up	2 k 1.5 k	10 w 5 w	Fixed Fixed	WW WW	5% 5%	Use 308-055 308-002
R126	101-844 845 and up	680 Ω 330 Ω	2 w 2 w	Fixed Fixed	Comp. Comp.	Selected*** Selected***	
R126.1	X845 and up	330 Ω	2 w	Fixed	Comp.	Selected***	
R127	101-844 845 and up	680 Ω 330 Ω	2 w 2 w	Fixed Fixed	Comp. Comp.	Selected*** Selected***	
R127.1	X845 and up	330 Ω	2 w	Fixed	Comp.	Selected***	
R128	101 and up	47 Ω	1/2 w	Fixed	Comp.	10%	302-470
R129	X845-5099 5100 and up	10 k 4.7 k	1/2 w 1/2 w	Fixed Fixed	Comp. Comp.	10% 10%	302-103 302-472
R130	101-454 455-867 868 and up	100 k 220 k 100 k	1/2 w 1/2 w 1/2 w	Fixed Fixed Fixed	Comp. Comp. Comp.	10% 10% 10%	302-104 302-224 302-104
R131A,B	101-1489 1490-3299 3300-5099 5100 and up	500 k 250 k 220 k 220 k(dual)	1/4 w 1/4 w 1/4 w 2 w	Var. Var. Var. Var.	Comp. Comp. Comp. Comp.	20%** 20%** 20%** 20%	311-031
R132	101-454 455-867 868 and up	100 k 82 k 33 k	1/2 w 1/2 w 1/2 w	Fixed Fixed Fixed	Comp. Comp. Comp.	10% 10% 10%	302-104 302-823 302-333
R134	101-800 801 and up	1.11 meg 1.11 meg	1 w 1/2 w	Fixed Fixed	Prec. Prec.	1% 1%	Use 309-015 309-015
R135	101-5099 5100 and up	500 k 500 k	1/4 w 2 w	Var. Var.	Comp. Comp.	20% 20%	Use 311-034 311-034

*R121 and R122 selected to total 420 Ω, +or-5%. Furnished as a unit.

***Selected in groups of four with total series resistance 1150 Ω, +or-2%. Furnished as a unit with R111, R112. Total 8 resistors, part number, 312-546.



R136	101 and up	1.5 meg	1/2 w	Fixed	Comp.	10%	302-155
R137	101-454	1 meg	1/2 w	Fixed	Comp.	10%	302-105
	455-844	1.5 meg	1/2 w	Fixed	Comp.	10%	302-155
	845 and up	1 meg	1/2 w	Fixed	Comp.	10%	302-105
R138	101 and up	120 k	1/2 w	Fixed	Comp.	10%	302-124
R139	101 and up	4.7 meg	2 w	Fixed	Comp.	10%	306-475
R140	101-5099	2 meg	1/4 w	Var.	Comp.	20%	Use 311-042
	5100 and up	2 meg	2 w	Var.	Comp.	20%	311-042
R141	101 and up	1.5 meg	1/2 w	Fixed	Comp.	10%	302-155
R142	101-5099	500 k	1/4 w	Var.	Comp.	20%	Use 311-034
	5100 and up	500 k	2 w	Var.	Comp.	20%	311-034
R149	X455 and up	1 k	25 w	Fixed	WW	5%	308-037
R150	101-454	4.7 meg	2 w	Fixed	Comp.	10%	306-475
	455 and up	470 k	1/2 w	Fixed	Comp.	10%	302-474
R151	101-454	4.7 meg	2 w	Fixed	Comp.	10%	306-475
	455-779	220 k	1/2 w	Fixed	Comp.	10%	302-224
	780 and up	150 k	1/2 w	Fixed	Comp.	10%	302-154
R152	101-454	220 k	2 w	Fixed	Comp.	10%	306-224
	455 and up	47 k	1/2 w	Fixed	Comp.	10%	302-473
R153	101-454	820 k	1 w	Fixed	Comp.	10%	304-824
	455 and up	220 k	1 w	Fixed	Comp.	10%	304-224
R154	101-454	820 k	1 w	Fixed	Comp.	10%	304-824
	455-5099	1 meg	1/2 w	Fixed	Comp.	5%	Use 312-524
	5100 and up	1 meg	1/2 w	Fixed	Comp.	+3to+5%	312-524
R155	101-454	220 k	2 w	Fixed	Comp.	10%	306-224
	455-5099	1 meg	1/2 w	Fixed	Comp.	5%	Use 312-525
	5100 and up	1 meg	1/2 w	Fixed	Comp.	-3to-5%	312-525
R156	101-454	5 k	10 w	Fixed	WW	5%	Use (2) 308-023*
	455 and up	470 k	1/2 w	Fixed	Comp.	10%	302-474
R157	101-454	470 Ω	1 w	Fixed	Comp.	10%	304-471
	455 and up	47 k	1/2 w	Fixed	Comp.	10%	302-473
R158	X455 and up	27 k	1/2 w	Fixed	Comp.	10%	302-273
R159	X455-5099	100 k	1/4 w	Var.	Comp.	20%	Use 311-026
	5100 and up	100 k	2 w	Var.	Comp.	20%	311-026
R160	101 and up	470 k	1/2 w	Fixed	Comp.	10%	302-474

*Note: Use (2) 308-023, 10 w in parallel.



R161	101-454 455 and up	10 k 270 k	1 w 1/2 w	Fixed Fixed	Comp. Comp.	10% 10%	304-103 302-274
R162	101-454 455 and up	10 k 470 k	1 w 1/2 w	Fixed Fixed	Comp. Comp.	10% 10%	304-103 302-474
R163	101-454 455-1051 1052 and up	470 k 4 k 3.5 k	1/2 w 20 w 20 w	Fixed Fixed Fixed	Comp. WW WW	10% 5% 5%	302-474 Use 308-032 308-032
R164	X455 and up	470 Ω	1 w	Fixed	Comp.	10%	304-471
R165	101-454 455-2699 2700 and up	15 k 15 k 10 k	10 w 2 w 2 w	Fixed Fixed Fixed	WW Comp. Comp.	5% 10% 10%	308-024 306-153 306-103
R165.2	X2700 and up	10 k	2 w	Var.	WW	20%	311-015
R166	101-454 455 and up	100 k 100 Ω	1/2 w 1/2 w	Fixed Fixed	Comp. Comp.	10% 10%	302-104 302-101
R167	101-454 455 and up	100 k 100 k	1/4 w 1/2 w	Var. Fixed	Comp. Comp.	20% 10%	311-026 302-104
R168	101-454X	47 k	1/2 w	Fixed	Comp.	10%	302-473
R170	101-454X	470 k	1/2 w	Fixed	Comp.	10%	302-474
R171	101-454 455 and up	680 k 820 k	1/2 w 1 w	Fixed Fixed	Comp. Comp.	10% 10%	302-684 304-824
R172	X455 and up	820 k	1 w	Fixed	Comp.	10%	304-824
R173	X455-844 845-5146 5147 and up	50 meg 50 meg 2-18 meg 1-15 meg	2 w 2 w 1/2 w 1/2 w	Fixed Fixed Fixed Fixed	Carbon Carbon Comp. Comp.	20% 10% 10% 10%	Use 310-517 310-517 Use 310-517
R174	X455-503 504-844X	470 k 1 meg	1/2 w 1/2 w	Fixed Fixed	Comp. Comp.	10% 10%	302-474 302-105
R175	X530 and up	27 k	1/2 w	Fixed	Comp.	10%	302-273

SWITCHES

			Unwired	Wired
SW1	101 and up	Trigger Selector	260-032	
SW2	101 and up	Sweep Range Front	260-046	262-023
SW2	101-5585 5586 and up	Sweep Range, Rear Sweep Range, Rear	260-047 260-047	262-017 262-024
SW3	101-2405X	Signal Calibrate	Use Mod Kit	040-015



SW3.1	X2406 and up	Signal Calibrate	260-040	262-025
SW4	101 and up	Input Attenuator	260-060	262-026
SW5	101 and up	Input Channel Selector	260-061	262-027
SW6	101 and up	Sweep Magnifier	See R52,	311-027
SW7	101 and up	Power	Use 260-134	
SW9	X845 and up	Vertical Deflection Polarity	260-015	
SW10	X1406 and up	Sweep Speed Multiplier	260-035	262-028
SW201	X5100 and up	Delay	260-025	

TRANSFORMERS

Some of the earlier 511 T-1 transformers had an additional 6.3 volt secondary not shown on the diagram. Later transformers eliminated this winding, supplying all filament voltages from T-2. If replacement is necessary, determine whether both transformers supply the filament voltages; if so, replace both T-1 and T-2, connecting all filament leads to T-2. This is easily done at the transformer terminal boards.

T1	101-454	Primary: 117 volt, 50-60 cycle	120-013
		Secondaries: 440-0-440 v , 125 ma. with one winding extended to 1250 v at 1 ma. 5 v , 3 a., insulated for 500 v. 2.5 v , 1.75 a., insulated for 1250 v., RMS. 2.5 v , 1.75 a., insulated for -1600 v. 6.3 v , 0.6 a., insulated for -1600 v.	
T2	101-454	Primary: 117 volt, 50-60 cycle.	120-014
		Secondaries: 275-0-275 v , 135 ma. 5 v , 3 a., insulated for 350 v. 6.3 v , 0.6 a., insulated for 275 v. RMS. 6.3 v , 1.5 a., insulated for 225 v. 35.4 v, tapped at 3.54 v. 6.3 v , 8 a, ground	
T1	455 and up	Primary: 117 or 235 volt, 50-60 cycle	120-017
		Secondaries: 280-0-280 v , 250 ma. 260-0-260 v., 30 ma. insulated for 700 v DC. 5 v , 4 a., insulated for 500 v DC. 6.3 v , 6 a. , insulated for 500 v DC. 63 v , 6 a., insulated for 650 v DC. 6.3 v , 6 a., insulated for 350 v , RMS. 6.3 v , 3 a., insulated for 250 v DC. 6.3 v , 6 a., insulated for 1500 v DC. 6.3 v , 11 a, grounded 35.4 v , RMS, ground	



T2	455 and up	Primary: 170 v, tapped at 25 v, approx., 2 KC. for instruments with 1B3 HV rectifiers	120-016 OR 120-015
		Secondaries: 1250 v, at 1 ma. 1.4 v, .2 a., connected to 1250 v winding 1.4 v, .2 a., insulated for 1500 v DC	

VACUUM TUBES

V1	101 and up	6AC7	154-011
V2	101 and up	6AG7	154-012
V3	101 and up	6AL5	154-016
V4	101 and up	6AC7	154-011
V5	101 and up	6AG7	154-012
V6	101 and up	6AL5	154-016
V7	101-2868X	6C4	154-029
V7.1	X2869-5099 5100 and up	12AU7 12AT7	154-041 154-039
V8	101 and up	6C4	154-029
V9	101 and up	6AG7	154-012
V10	101 and up	6C4	154-029
V11	101 and up	6J6	154-032
V12	101 and up	6AL5	154-016
V13	101 and up	6AU6	154-022
V14	101 and up	6AU6	154-022
V15	101-454 455 and up	OD3 6C4	154-003 154-029
V16	101 and up	6AG7	154-012
V16.1	X2406 and up	12AT7	154-039
V17	101 and up	6AG7	154-012
V18	101 and up	6AG7	154-012
V19	101 and up	6AG7	154-012
V20	101-5099 5100 and up	5CP1A 5ABP1	CRT CRT 154-062 154-068



V21	101-454 455 and up	5U4 6X4	154-086 154-035
V22	101-454 455 and up	2X2 5V4G	154-085 154-008
V23	101-454 455 and up	2X2 5V4G	154-085 154-008
V24	101-454 455 and up	5U4 6X4	154-086 154-035
V25	101-454 455 and up	6X5 6AQ5	154-090 154-017
V26	101-454 455 and up	OD3 6AU6	154-003 154-022
V27	101-454 455 and up	6SJ7 6AS7G	154-088 154-020
V28	101-454 455 and up	OC3 6AU6	154-002 154-022
V29	101-454 455 and up	6L6 5651	154-087 154-052
V30	101-454 455 and up	6V6 OD3	154-089 154-003
V31	X455 and up	6AQ5	154-017
V32	X455-3349X	1B3GT	154-091
V32.1	X3350 and up	1V2	154-004
V33	X455-3349X	1B3GT	154-091
V33.1	X3350 and up	1V2	154-004



DELAY LINE PARTS LIST

CAPACITORS

C1 to C4	101-5099X	3-12 $\mu\mu\text{f}$	Var.	Cer.		500 v	281-007
C1A to C23A	101-5099X	12 $\mu\mu\text{f}$	Fixed	Cer.	10%	500 v	281-506
C5 to C23	101-5099X	1.5-7 $\mu\mu\text{f}$	Var.	Cer.		500 v	281-005
C201-C204	X5100 and up	3-12 $\mu\mu\text{f}$	Var.	Cer.		500 v	281-007
C205-C223	X5100 and up	1.5-7 $\mu\mu\text{f}$	Var.	Cer.		500 v	281-005
C201A-C223A	X5100-5156	12 $\mu\mu\text{f}$	Fixed	Cer.	10%	500 v	281-506
C201A-C220A	5157 and up	12 $\mu\mu\text{f}$	Fixed	Cer.	10%	500 v	281-506
C221A-C223A	5157 and up	8 $\mu\mu\text{f}$	Fixed	Cer.	10%	500 v	281-503

INDUCTORS

L1-L12	101-5099X)	Fixed	Delay Line, 12-section		108-034
L13-L23	101-5099X)	Fixed	Delay Line, 11-section		108-033
L24	101-5099X	Var.	4.8-8.5 μh		114-020
L201-L212	X5100 and up	Fixed	Delay Line, 12-section		108-034
L213-L223	X5100 and up	Fixed	Delay Line, 11-section		108-033
L224	X5100 and up	Var.	4.8-8.5 μh		114-020

RESISTORS

R1	101-5099X	270 Ω	1/2 w	Fixed	Comp.	10%	302-271
R2	101-5099X	Selected*	1/2 w	Fixed	Comp.		
R201	X5100 and up	Selected*	1/2 w	Fixed	Comp.	10%	302-271
R202	X5100 and up	Selected*	1/2 w	Fixed	Comp.	10%	

*As determined by calibration.

SWITCHES

S1	101-5099X	In-Out	DPDT	Rotary		260-025
SW201	X5100 and up	1 wafer, rotary, 2 position				260-025

RELAY

RL1 (1-D-25)	101-454	Type 227A	DPDT	32 v, DC, 100 Ω		148-001
-----------------	---------	-----------	------	------------------------	--	---------

For replacement of complete delay line, S/N's 101 through 454, order Delay Line Kit, 040-021.
For replacement of complete delay line, S/N's 455 and up, order Delay Line Kit, 040-068.



SECTION 7

TEKTRONIX TYPE 1-AD-25 AND 1-D-25

DELAY NETWORK

GENERAL DESCRIPTION

The Type 1-AD-25 Video Delay Network is designed for use in the video amplifier of the Tektronix Type 511A Oscilloscope. It provides a signal delay of .25 microsecond, thus permitting the CRT to be unblanked and the sweep to be operating linearly, before the initiating signal reaches the vertical deflection plates. By this method, random pulses may be observed.

The Type 511AD Oscilloscope includes a factory-installed Type 1-AD-25 Delay Network.

The Type 1-AD-25 consists of 23 M-derived sections. By using $M=1.27$, very uniform time delay is obtained for frequencies well above the cutoff of the Type 511A output amplifier. To obtain smooth impedance matching between sections of the network, trimming capacitors are provided. These are adjusted at the factory and should not require resetting in the field.

The output termination consists of the Vert. Ampl. Atten. potentiometer, shunted by R2 (R202, S/N 5100 and up) to match the characteristic impedance of the network. To make this termination less critical, the network is partially matched at the input by the 270 ohm resistor R1 (R201, S/N 5100 and up) in series with the internal impedance of the cathode follower, V17.

This input matching produces an insertion loss of 3 db., but is necessary since the impedance of the output termination varies slightly with the setting of the Vert. Ampl. Atten. potentiometer.

When the delay network is not needed, it may be removed from the circuit by means of a rotary switch operated from the front panel.

ADJUSTMENT AND MAINTENANCE

If the Vert. Ampl. Atten. potentiometer, R107, or the limiting resistor, R108, are replaced, it may be necessary to change the delay network shunt resistance so that the correct termination is maintained. To check for proper termination, set the sweep speed at 3 to 10 microseconds and observe the response to a clean, sharp, square wave or pulse having a risetime of .03 microseconds or less. The Tektronix Type 104 Square Wave Generator operating at 100 kc. provides such a signal.

If the termination is incorrect, the first .5 microsecond of the pulse will be lower or higher in amplitude than the rest of the flat portion. If the first part is higher, shunt the high side of R107 to ground with a resistor of such value that a level top on the square wave or pulse is obtained.

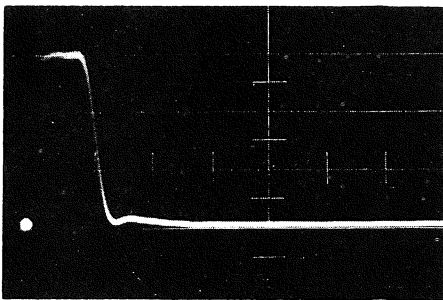

Fig. 7-1. 0.2 microsecond pulse with the delay network switched out. Note absence of leading edge.

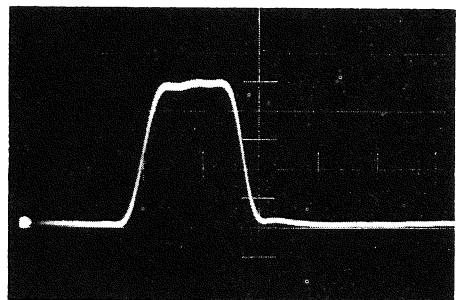

Fig. 7-2. The same 0.2 microsecond pulse with the Type 1-AD-25 delay network switched in, delaying the appearance of the pulse until the CRT is unblanked and the sweep operating linearly.



In case the first portion is lower, it will be necessary to increase the value of the shunt resistor. Remove the delay network cover and install a 1/2 watt resistor of suitable value (100 to 10,000 ohms), in series with R2

(R202, S/N 510 and up).

CAUTION: DO NOT DISTURB THE ADJUSTMENT OF THE VARIABLE CAPACITORS.



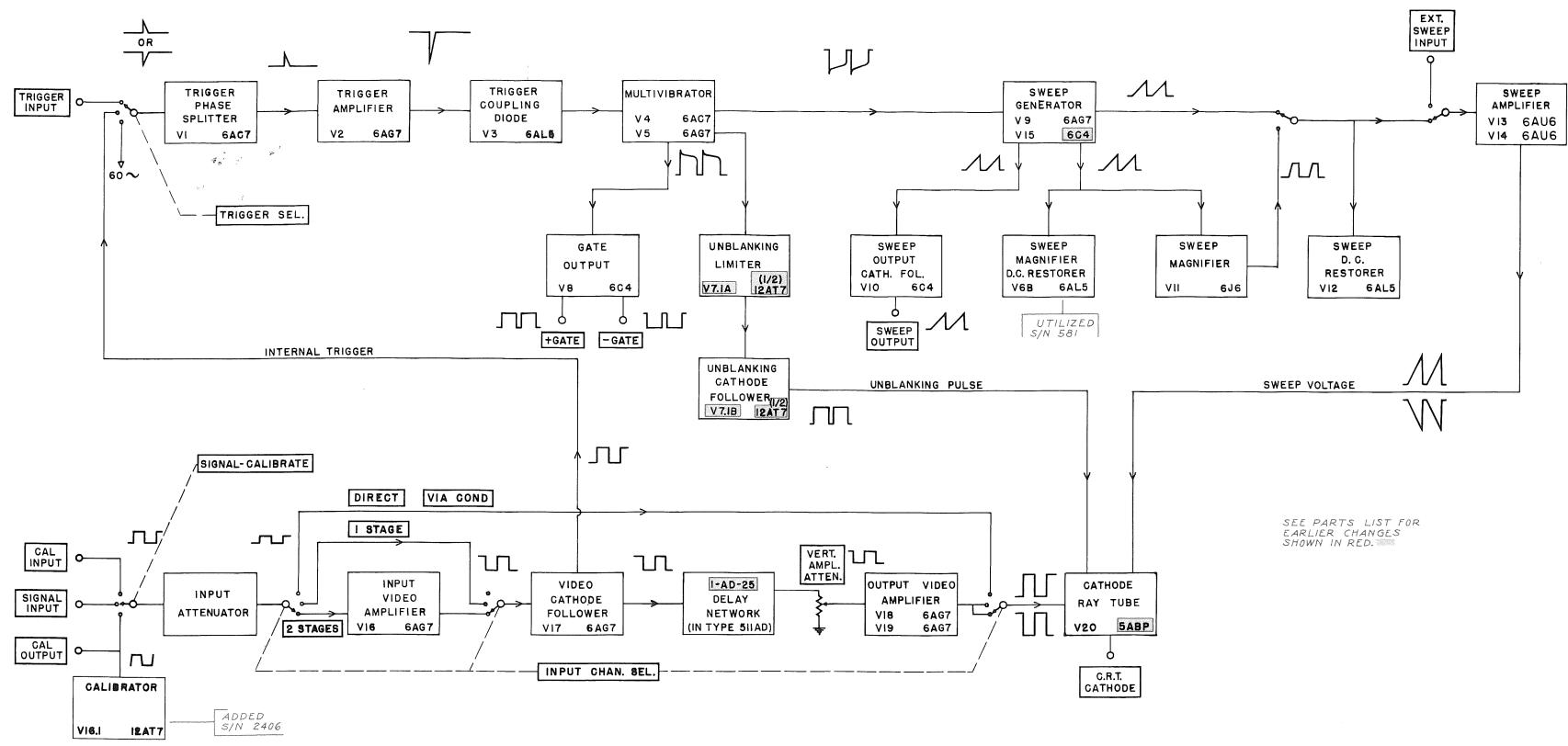

TYPE 511AD CATHODE-RAY OSCILLOSCOPE
S/N 101 & UP

A A

BLOCK DIAGRAM

11-12-53
L.H.P.

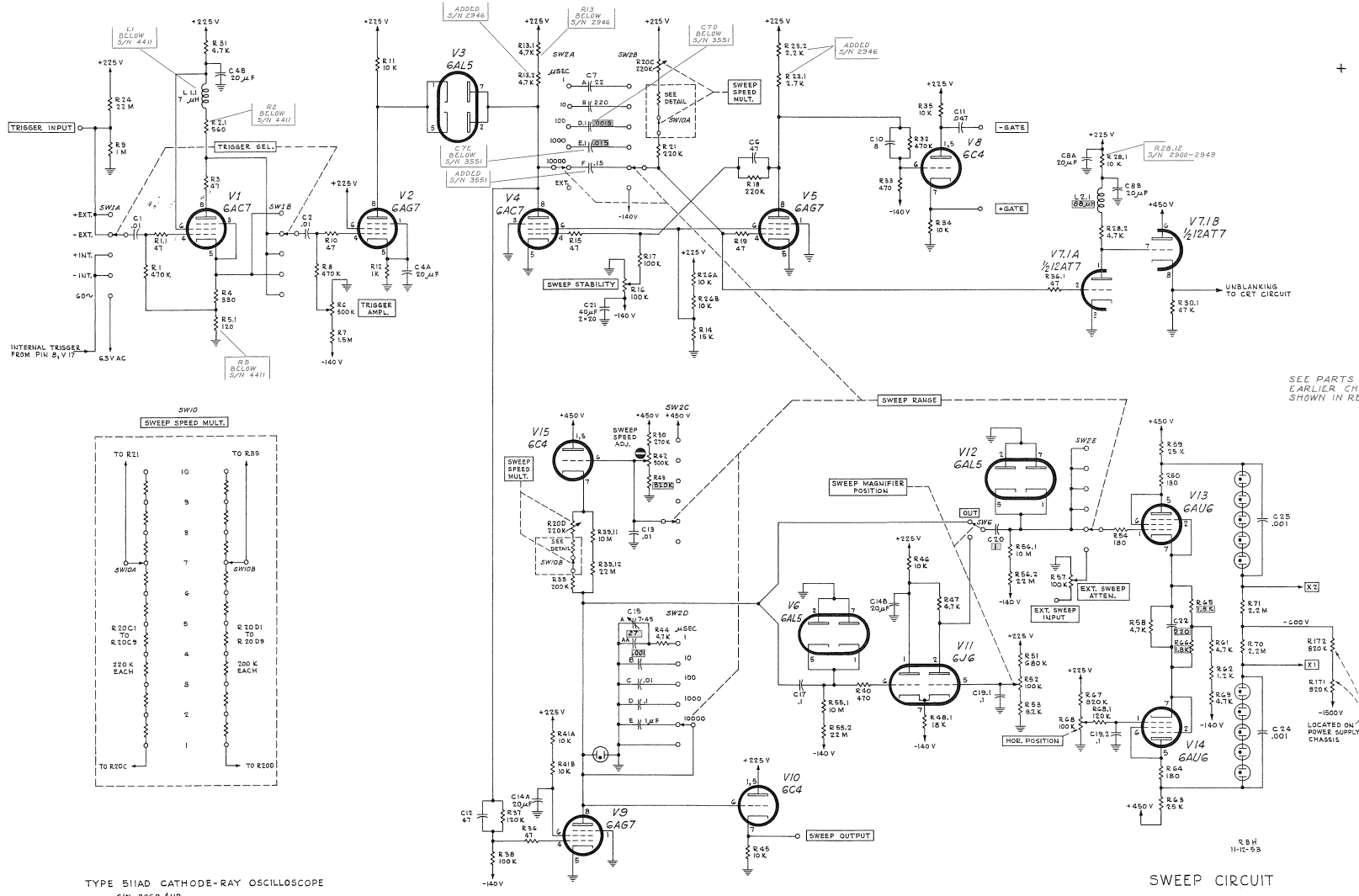

TYPE 511AD CATHODE-RAY OSCILLOSCOPE
S/N 2869 4UP

SWEEP CIRCUIT

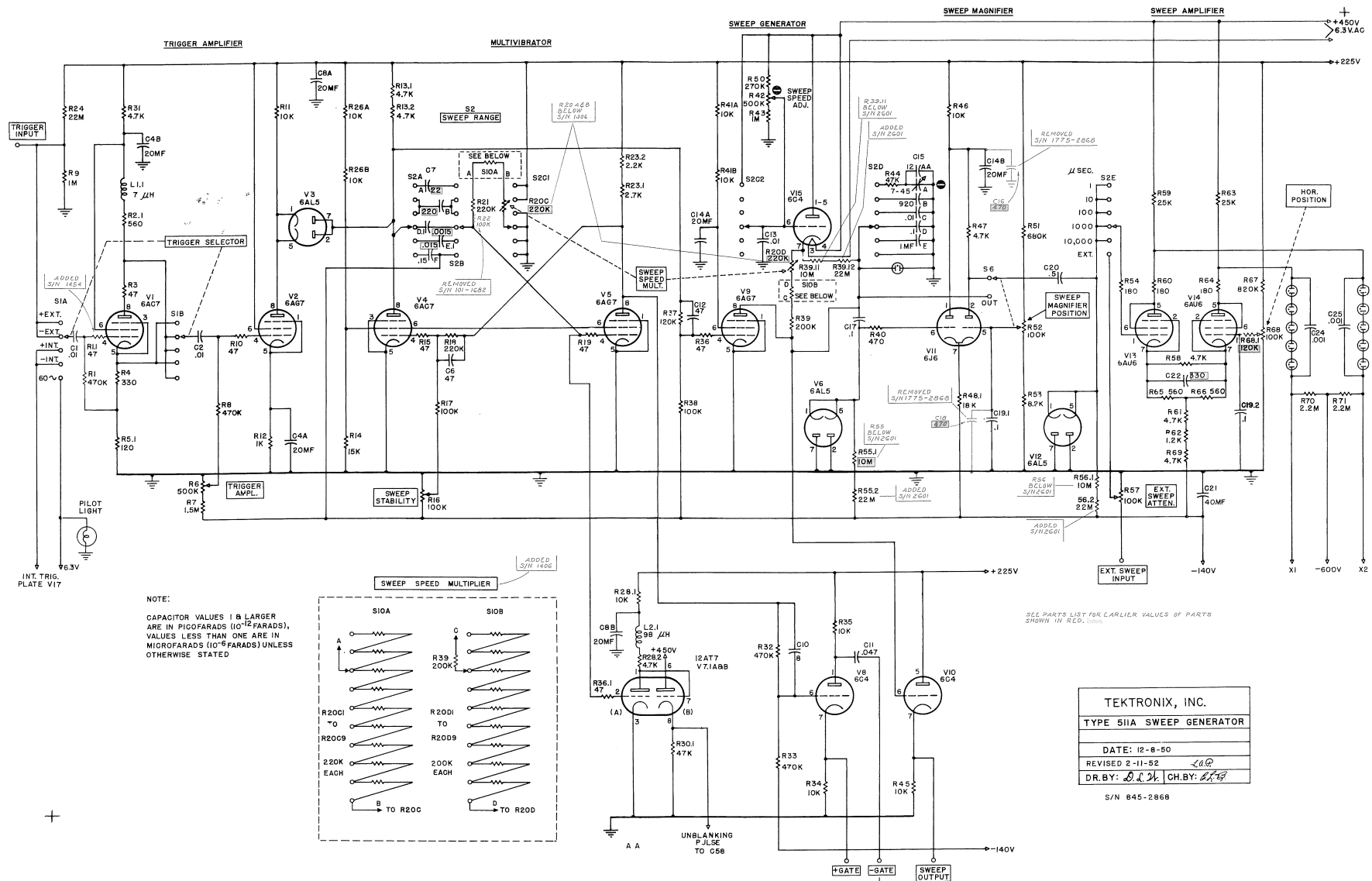

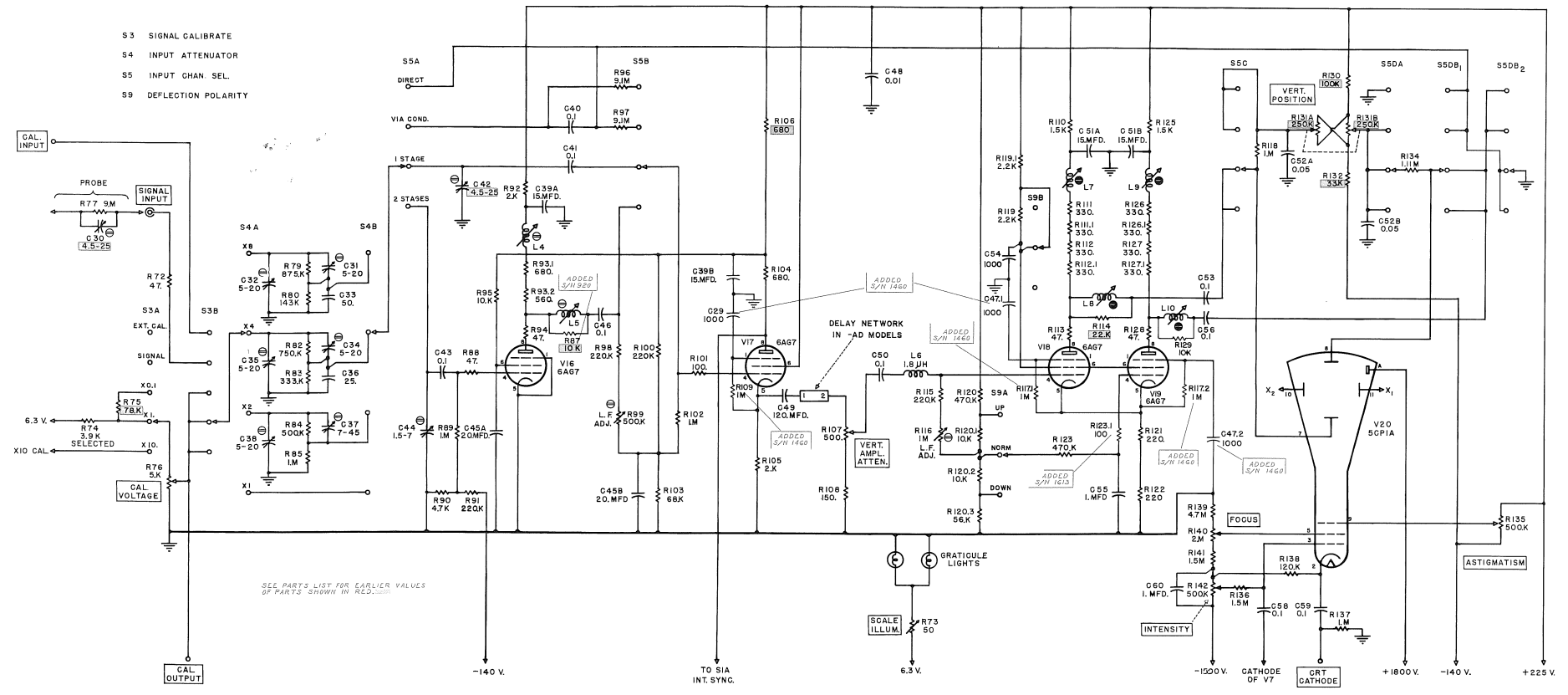

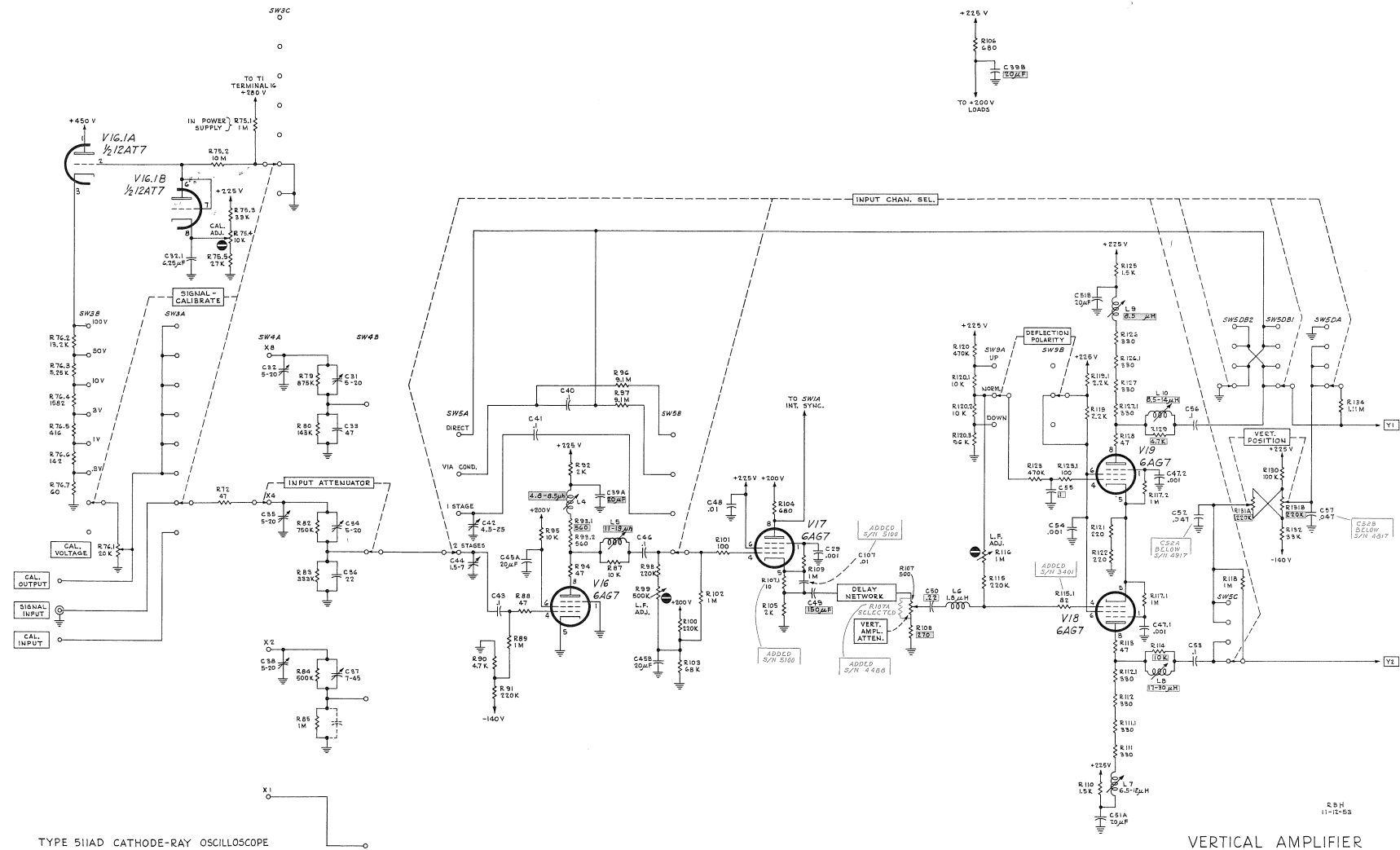

TYPE 511AD CATHODE-RAY OSCILLOSCOPE
S/N 2406 & UP

VERTICAL AMPLIFIER

R.B.H.
11-12-55

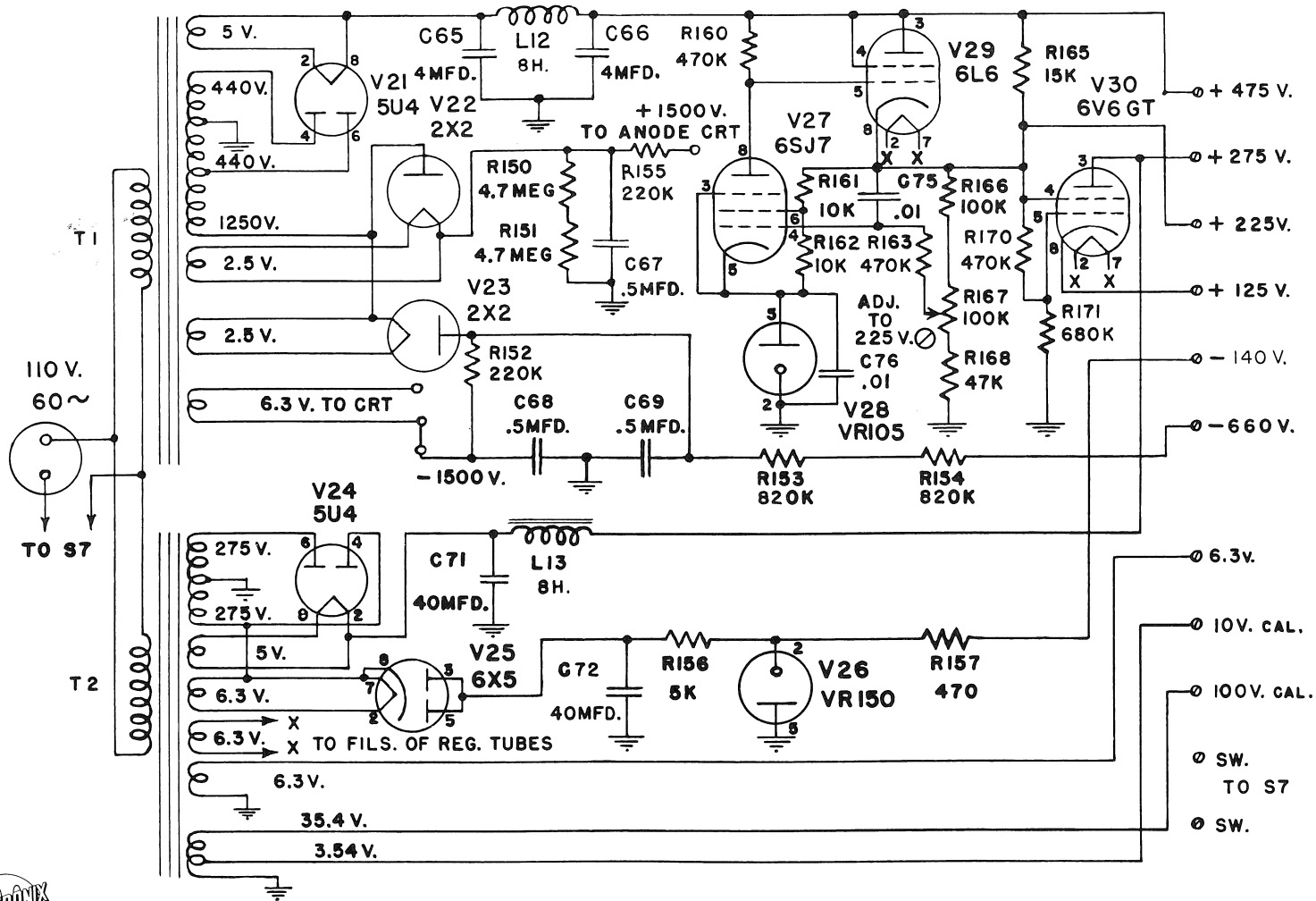

TYPE 511 CATHODE RAY OSCILLOSCOPE
S/N 101-454

AA

POWER SUPPLY

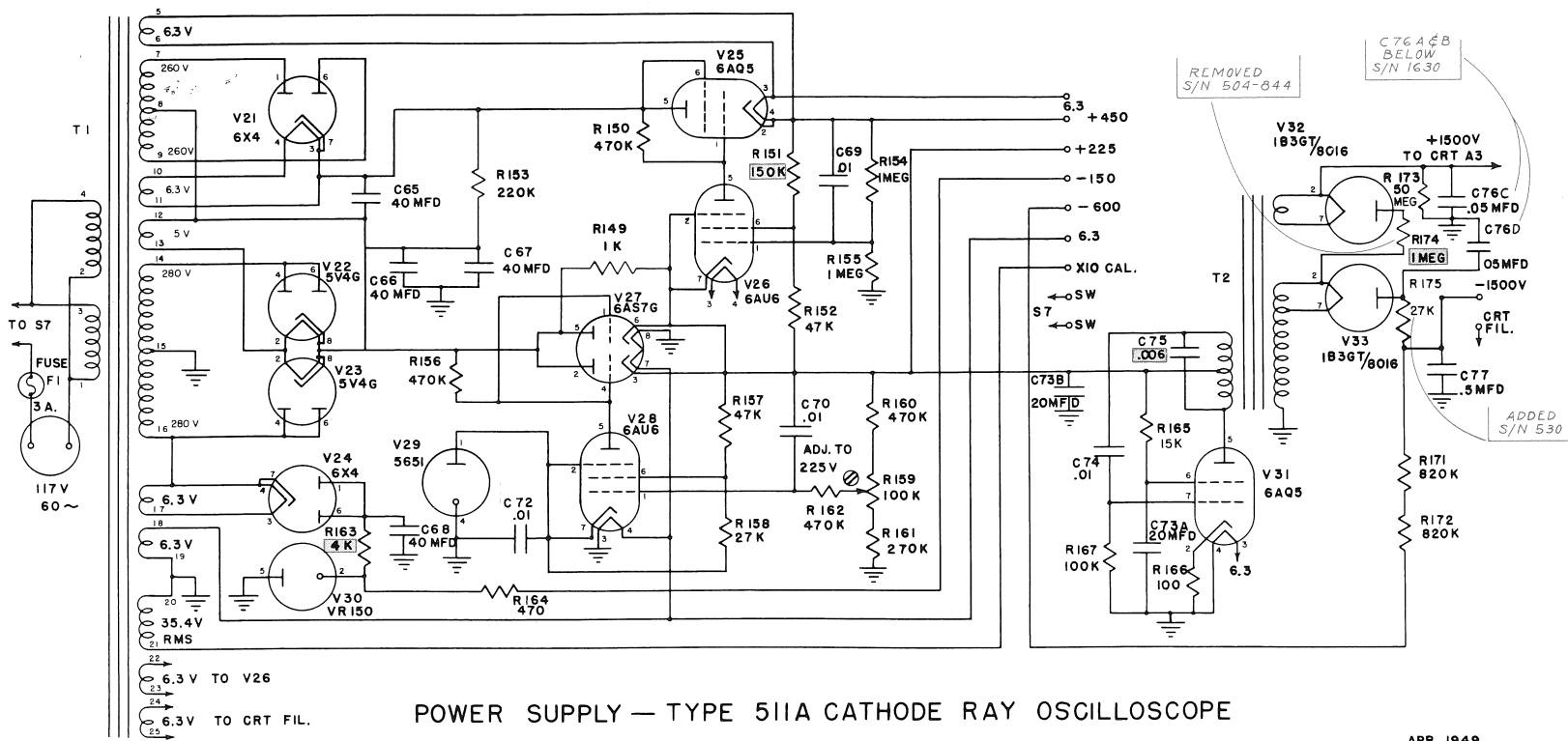

APR. 1949

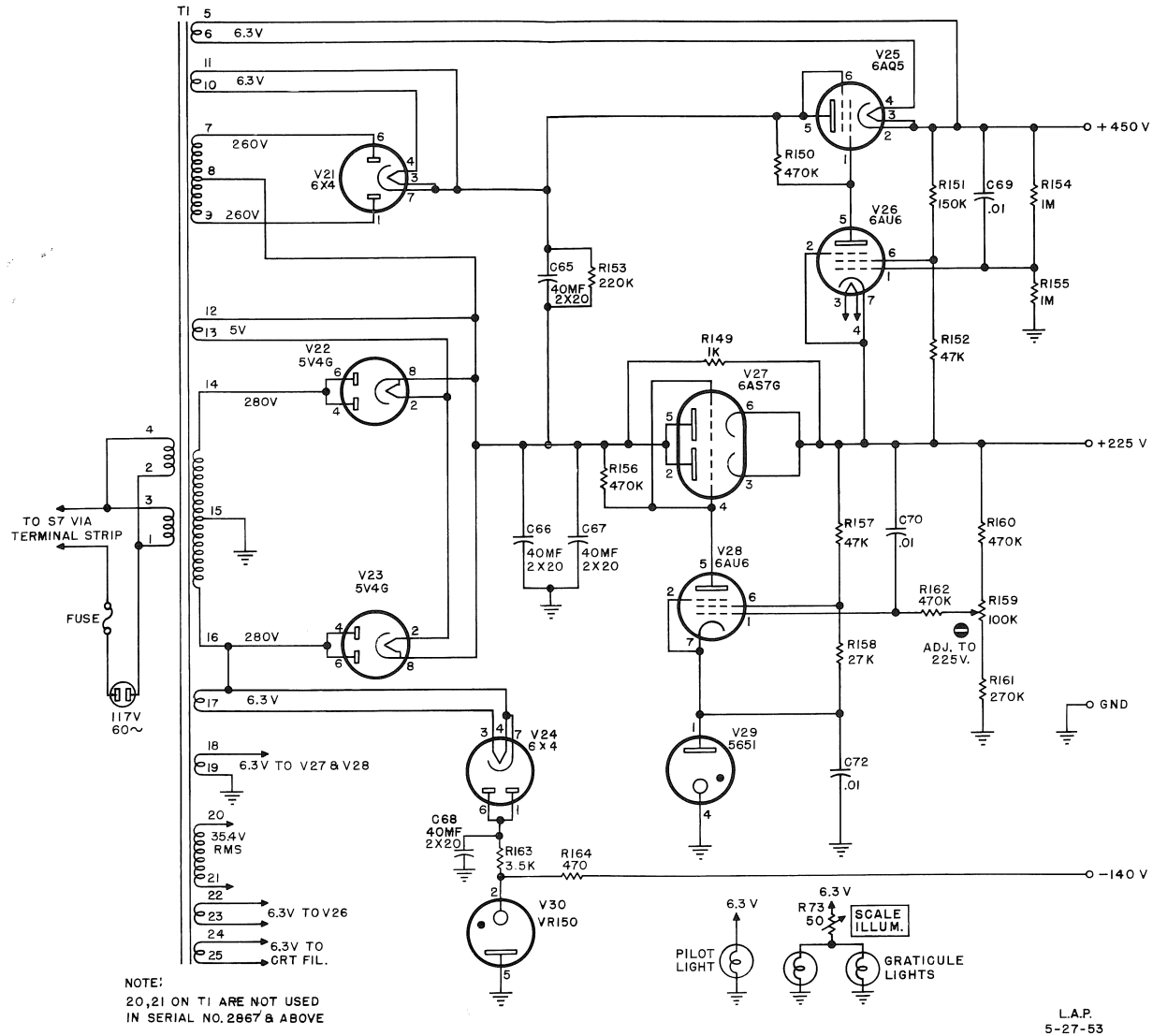

TYPE 511AD CATHODE-RAY OSCILLOSCOPE
S/N 2406 & UP

AA

L V POWER SUPPLY

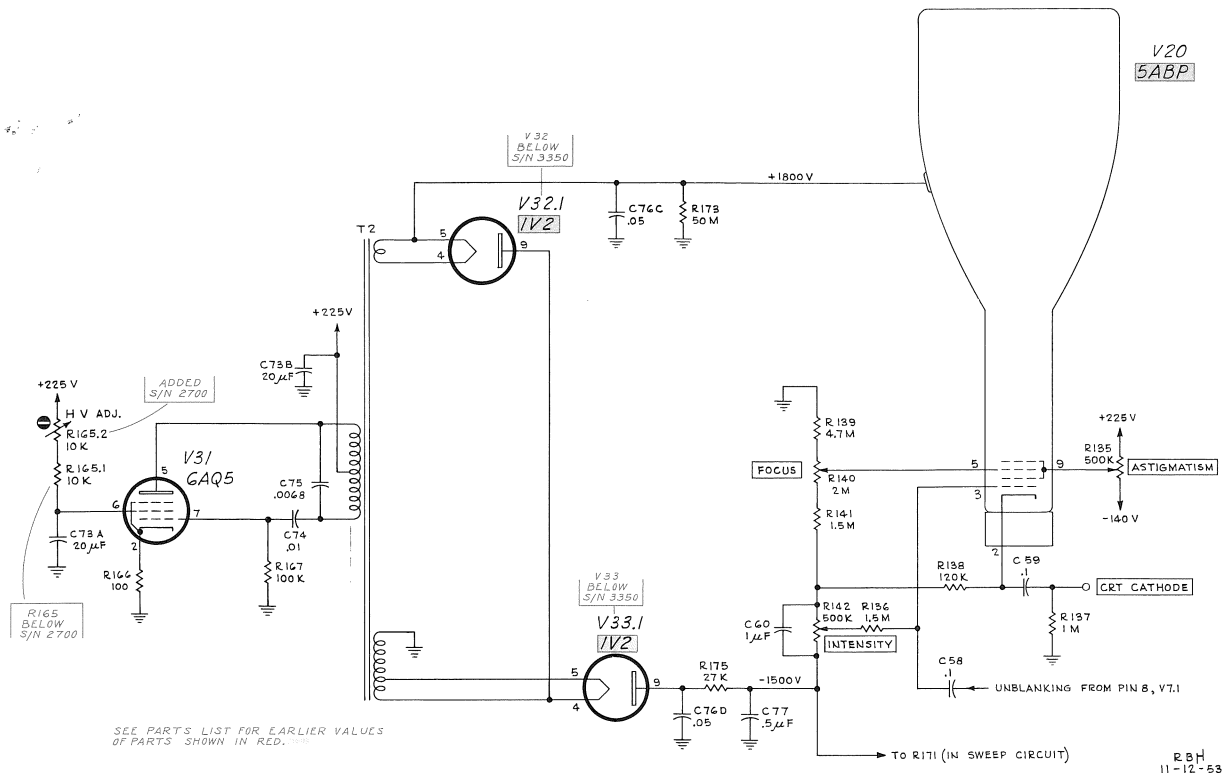

TYPE 511AD CATHODE-RAY OSCILLOSCOPE
S/N 2406 #UP

AA

HV POWER SUPPLY

